

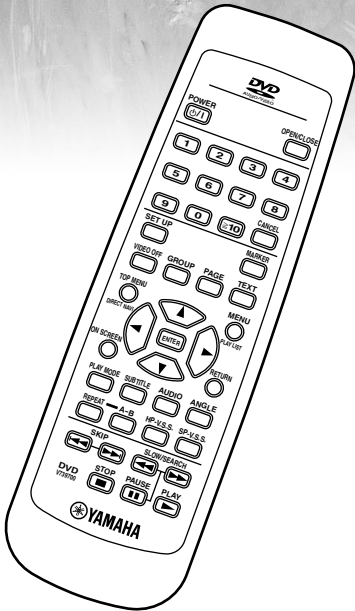

YAMAHA

U

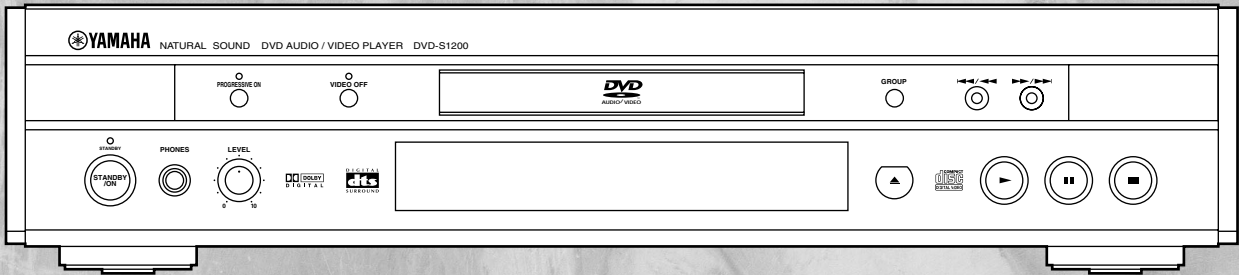

DVD AUDIO/VIDEO PLAYER

DVD-S1200

Owner's manual

Before connecting, operating or adjusting this product, please read these instructions completely. Please keep this manual for future reference.



Dear customer

Thank you for purchasing this product.
For optimum performance and safety, please read these instructions carefully.

CAUTION!

THIS PRODUCT UTILIZES A LASER. USE OF CONTROLS OR ADJUSTMENTS OR PERFORMANCE OF PROCEDURES OTHER THAN THOSE SPECIFIED HEREIN MAY RESULT IN HAZARDOUS RADIATION EXPOSURE. DO NOT OPEN COVERS AND DO NOT REPAIR YOURSELF. REFER SERVICING TO QUALIFIED PERSONNEL.

WARNING:

TO REDUCE THE RISK OF FIRE, ELECTRIC SHOCK OR PRODUCT DAMAGE, DO NOT EXPOSE THIS APPLIANCE TO RAIN, SPLASHING, DRIPPING OR MOISTURE.

CAUTION:

TO PREVENT ELECTRIC SHOCK MATCH WIDE BLADE OF PLUG TO WIDE SLOT, FULLY INSERT. This Class B digital apparatus complies with Canadian ICES-003.



CAUTION
RISK OF ELECTRIC SHOCK
DO NOT OPEN



CAUTION: TO REDUCE THE RISK OF ELECTRIC SHOCK, DO NOT REMOVE SCREWS. NO USER-SERVICEABLE PARTS INSIDE. REFER SERVICING TO QUALIFIED SERVICE PERSONNEL.



The lightning flash with arrowhead symbol, within an equilateral triangle, is intended to alert the user to the presence of uninsulated "dangerous voltage" within the product's enclosure that may be of sufficient magnitude to constitute a risk of electric shock to persons.



The exclamation point within an equilateral triangle is intended to alert the user to the presence of important operating and maintenance (servicing) instructions in the literature accompanying the appliance.

FCC INFORMATION (for US customers only)

- IMPORTANT NOTICE: DO NOT MODIFY THIS UNIT!** This product, when installed as indicated in the instructions contained in this manual, meets FCC requirements. Modifications not expressly approved by Yamaha may void your authority, granted by the FCC, to use the product.
- IMPORTANT:** When connecting this product to accessories and/or another product use only high quality shielded cables. Cable/s supplied with this product **MUST** be used. Follow all installation instructions. Failure to follow instructions could void your FCC authorization to use this product in the USA.
- NOTE:** This product has been tested and found to comply with the requirements listed in FCC Regulations, Part 15 for Class "B" digital devices. Compliance with these requirements provides a reasonable level of assurance that your use of this product in a residential environment will not result in harmful interference with other electronic devices.

This equipment generates/uses radio frequencies and, if not installed and used according to the instructions found in the users manual, may cause interference harmful to the operation of other electronic devices.

Compliance with FCC regulations does not guarantee that interference will not occur in all installations. If this product is found to be the source of interference, which can be determined by turning the unit "OFF" and "ON", please try to eliminate the problem by using one of the following measures:

Relocate either this product or the device that is being affected by the interference.

Utilize power outlets that are on different branch (circuit breaker or fuse) circuits or install AC line filter/s.

In the case of radio or TV interference, relocate/reorient the antenna. If the antenna lead-in is 300 ohm ribbon lead, change the lead-in to coaxial type cable.

If these corrective measures do not produce satisfactory results, please contact the local retailer authorized to distribute this type of product. If you can not locate the appropriate retailer, please contact Yamaha Electronics Corp., U.S.A. 6660 Orangethorpe Ave, Buena Park, CA 90620

The above statements apply **ONLY** to those products distributed by Yamaha Corporation of America or its subsidiaries.

We Want You Listening For A Lifetime

YAMAHA and the Electronic Industries Association's Consumer Electronics Group want you to get the most out of your equipment by playing it at a safe level. One that lets the sound come through loud and clear without annoying blaring or distortion—and, most importantly, without affecting your sensitive hearing. Since hearing damage from loud sounds is often undetectable until it is too late, YAMAHA and the Electronic Industries Association's Consumer Electronics Group recommend you to avoid prolonged exposure from excessive volume levels.



DANGER	- VISIBLE AND INVISIBLE LASER RADIATION WHEN OPEN. AVOID DIRECT EXPOSURE TO BEAM. (FDA 21 CFR)
CAUTION	- VISIBLE AND INVISIBLE LASER RADIATION WHEN OPEN. AVOID EXPOSURE TO BEAM. (IEC60825-1)
ATTENTION	- RAYONNEMENT LASER VISIBLE ET INVISIBLE EN CAS D'OUVERTURE. EXPOSITION DANGEREUSE AU FAISCEAU.
ADVARSEL	- SYNLIG OG USYNLIG LASERSTRÅLING VED ÅBNING. UNDGÅ UDSÆTTELSE FOR STRÅLING.
VARO!	- AVATTAESSA OLET ALTTIINA NÄKYVÄÄ JA NÄKYMÄTÖN LASERSÄTEILYLLÄ. ÄLÄ KATSO SÄTEESEEN.
VARNING	- SYNLIG OCH OSYNLIG LASERSTRÅLNING NÄR DENNA DEL ÄR ÖPPNAD. BETRÄKTA EJ STRÅLEN.
ADVARSEL	- SYNLIG OG USYNLIG LASERSTRÅLING NÄR DEKSEL ÅPNES. UNNGÅ EKSPONERING FOR STRÅLEN.
VORSICHT	- SICHTBARE UND UNSICHTBARE LASERSTRAHLUNG, WENN ABDECKUNG GEÖFFNET. NICHT DEM STRAHL AUSSETZEN.
注意	- 打开时有可见及不可见激光辐射。避免激光束照射。
注意	- ここを開くと可視及び不可視のレーザー光が出ます。ビームを直接見たり、触れたりしないでください。 RQLS0233

(Inside of product)

Getting started

Accessories	3
PRECAUTIONS	4
Disc information	5
Disc handling	6
The remote control	6
Control reference guide	7
Connection	8
Connecting an AV amplifier with a built-in decoder	9
Connection to digital audio equipment without a decoder	9
Connecting an AV amplifier with 5.1-channel audio input terminals	10
Analog connection to a 2-channel amplifier or system component	10
Connections using the S video or component video terminals	11
Recording to MDs or cassette tapes	11

Basic operations

Basic play	12
Resume function	13
Starting play from a selected program, title, or track	13
Skipping	14
Frame-by-frame viewing	14
Fast forward and rewind—SEARCH	14
Slow-motion play	14
Selecting still pictures—Page Skip	15
Selecting groups to play	15
To enjoy even higher quality sound—VIDEO OFF	15
To enjoy even higher quality picture—PROGRESSIVE ON	15

Advanced operations

Marking places to play again—MARKER	16
Changing the play sequence	17
All group play/Random play	17
Program play	18
Playing the programs on DVD-RAM	19
Selecting programs to play—DIRECT NAVIGATOR	19
Using the play list menu to play specific scenes	20

Repeat play	21
Repeat play/A-B repeat play	21
Increasing your enjoyment of movies and music	22
Enjoying virtual surround effects with 2 speakers or headphones (VIRTUAL SURROUND (V.S.S.))	22
Using headphones	22
Changing soundtracks, subtitle languages and angles	23
Using On-Screen Menu Icons	24
Common procedures	24
Icons for disc information/Shuttle screen	25
Icons for unit information	26
Changing settings	28
Common procedures	28
Summary of settings	29
Entering a password	30
Television settings	31
Speaker setting	32
Digital output	33

Reference

Glossary	34
Troubleshooting guide	35
Maintenance	36
Specifications	37

Accessories



Please check and identify the supplied accessories.

- | | | | | | | | |
|---|---|------------------------------------|---|---|---|--|---|
| <input type="checkbox"/> Remote control | 1 | <input type="checkbox"/> Batteries | 2 | <input type="checkbox"/> AC power supply cord | 1 | <input type="checkbox"/> Audio/Video cable | 1 |
|---|---|------------------------------------|---|---|---|--|---|

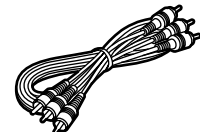
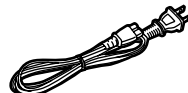
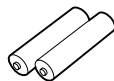

Note

The included AC power supply cord is for use with this unit only. Be sure to use the included AC power supply cord with this unit.

PRECAUTIONS

Before using this unit please read these operating instructions carefully. Take special care to follow the warnings indicated on the unit itself as well as the safety suggestions listed below.

Afterwards keep them handy for future reference.

Getting started

Safety

- 1. Power Source**—The unit should be connected to a power supply only of the type described in the operating instructions or as marked on the unit. If you are not sure of the type of power supply to your home, consult your appliance dealer or local power company.
- 2. Polarization**—If the unit is equipped with a polarized AC power plug (a plug having one blade wider than the other), that plug will fit into the AC outlet only one way. This is a safety feature. If you are unable to insert the plug fully into the outlet, try reversing the plug. If the plug should still fail to fit, contact your electrician to replace your obsolete outlet. Do not defeat the safety purpose of the polarized plug.
- 3. Power Cord Protection**—AC power supply cords should be routed so that they are not likely to be walked on or pinched by items placed upon or against them. Never take hold of the plug or cord if your hand is wet, and always grasp the plug body when connecting or disconnecting it.
- 4. Overloading**—Do not overload wall outlets and extension cords as this can result in a risk of fire or electric shock.
- 5. Nonuse Periods**—When the unit is not being used, turn the power off. When left unused for a long time, the unit should be unplugged from the household AC outlet.
- 6. Attachments**—Do not use attachments not recommended by the unit manufacturer as they may cause hazards.

Installation

Environment

- 1. Water and Moisture**—Do not use this unit near water—for example, near a bathtub, washbowl, swimming pool, or the like. Damp basements should also be avoided.
- 2. Condensation**—Moisture may form on the lens in the following conditions...
 - immediately after a heater has been turned on.
 - in a steamy or very humid room.
 - when the unit is suddenly moved from a cold environment to a warm one.If moisture forms inside this unit, it may not operate properly. To correct this problem, turn on the power and wait about one hour for the moisture to evaporate.
- 3. Heat**—The unit should be situated away from heat sources such as radiators and the like. It also should not be placed in temperatures less than 5 °C (41 °F) or greater than 35 °C (95 °F).

Do not place the unit on amplifiers or equipment that may become hot.

The heat can damage the unit.



Placement

- 1. Ventilation**—The unit should be situated so that its location or position does not interfere with its proper ventilation. Allow 10 cm (4") clearance from the rear of the unit.
- 2. Foreign Material**—Care should be taken so that objects do not fall into and liquids are not spilled into the unit. Do not subject this unit to excessive smoke, dust, mechanical vibration, or shock.
- 3. Carts and Stands**—The unit should be used only with a cart or stand that is recommended by the manufacturer. The unit and cart combination should be moved with care. Quick stops, excessive force, and uneven surfaces may cause the unit and cart combination to overturn.
- 4. Mounting**—Any mounting of the appliance should follow the manufacturer's instructions, and should use a mounting accessory recommended by the manufacturer.



Maintenance

Disconnect this unit from the AC outlet before cleaning.

Clean the cabinet, panel and controls with a soft cloth lightly moistened with a mild detergent solution.

Do not use any type of abrasive pad, scouring powder or solvent such as alcohol or benzine.

The model number and serial number of this product can be found on either the back or the bottom of the unit. Please note them in the space provided below and keep for future reference.

MODEL NUMBER _____ DVD-S1200 _____

SERIAL NUMBER _____

Discs that can be played

Disc type	Logo	Region number	Video system	Indication used in instructions
DVD-RAM (4.7 GB)		—	NTSC	RAM
DVD-Audio		—	NTSC (and PAL, but audio only)	DVD-A
DVD-Video		1 ALL	NTSC	DVD-V
Video CD		—	NTSC	VCD
Audio CD		—	—	CD

Discs that cannot be played

PAL discs (the audio on DVD-Audio can be played), DVD-RAM (2.6 GB, TYPE 1), DVD-ROM, DVD-R (some DVD-R can be played), CD-ROM, CDV, CD-G, +RW, DVD-RW, CVD, SVCD, SACD, Divx Video Discs and Photo CD.

DVDs that can be played

This unit has a Dolby Digital decoder so you can play DVDs with this mark.

This unit has a DTS decoder so you can play DVDs with this mark.

Region Management Information (DVD-Video only)

This unit responds to the Region Management Information recorded on DVD-Video. This unit's region number is "1". You cannot play the disc if the region number on the DVD-Video does not correspond to the region number on the unit.

You can play discs with labels containing the region number "1" and "ALL". Read the disc's instructions carefully.

Playing DVDs and Video CDs

The producer of the material can control how these discs are played. This means that you may not be able to control play of a disc with some operations described in these operating instructions. Read the disc's instructions carefully.

DVD-RAM discs

DVD-RAM discs must meet the following conditions for this unit to be able to play them. It may not be possible to play some discs due to the condition of the recording.

Type	Non-cartridge discs Discs that can be removed from their cartridges (TYPE 2)
Capacity	12 cm 4.7 GB and 8 cm 2.8 GB
Recording format	Discs recorded with DVD video recorders, DVD video cameras, personal computers, etc., using Version 1.1 of the Video Recording Format (a unified video recording standard).

Note

- Remove TYPE 2 discs from their cartridges before use. Read the instructions for the disc carefully.
- Do not allow the disc to become dirty or scratched.
- Store discs in their cartridges. Be sure the label of the disc and the cartridge both face up when replacing the disc.

For your reference

Some parts of the disc, for example where one program ends and another begins, may not play smoothly.

4.7 GB TYPE 2 disc Non-cartridge 4.7 GB

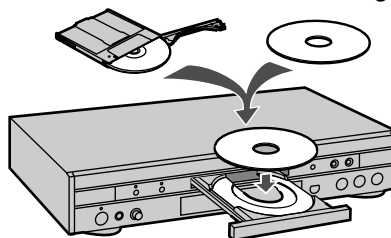

MP3 playback

You can use this unit to play MP3 format audio recorded for personal use with a computer etc. onto CD-R or CD-RW. Play may not be possible in some cases due to the condition of the recording. Discs recorded using MP3 differ to CDs in the following ways.

Structure of the disc (example)

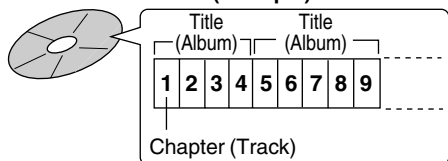

Starting play from a selected chapter

Press the numeric buttons and press [ENTER].

Example: Chapter 23: [2] → [3] → [ENTER]
(Pressing [≥ 10] is unnecessary.)

Repeat play

You can use chapter repeat or title repeat.

Program play, random play

You cannot use program play or random play.

Note

Not compatible with multi-session recordings

If you record MP3 onto CD-R/CD-RW over a number of sessions, this unit can play only the recordings made in the first session.

Recordings will not necessarily be played in the order you recorded them. The recordings will be reordered according to their titles: numbers in numerical order first, upper case in alphabetical order next, and lower case in alphabetical order last.

If you play an MP3 track that includes still picture data, it will take some time before the music itself starts playing and the elapsed time will not be displayed during this time. Even after the track starts, the correct play time will not be displayed.

Display during play



On-Screen Menu Icons for disc information during play

Total number of chapters

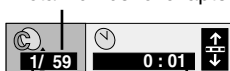

Current chapter

Elapsed play time

(display only, cannot be changed)

Disc handling

Do not use irregularly shaped discs, such as heart-shaped. (These can damage the unit.)

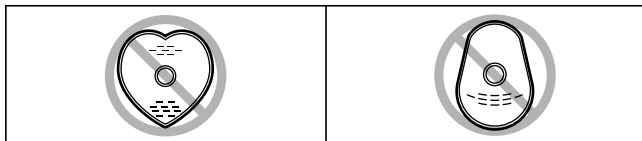

■ How to hold a disc

Do not touch the recorded surface.

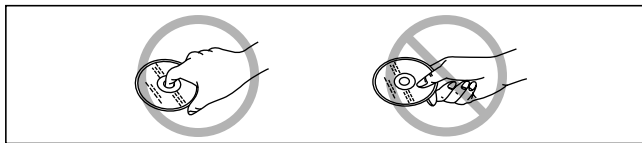

■ If the surface is dirty

DVD-Audio, DVD-Video, Video CD, CD

Wipe it with a damp cloth and then wipe dry.

Do not wipe with a circular motion; wipe straight outward from the center.

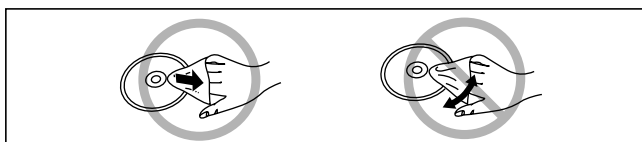

DVD-RAM

- Clean DVD-RAM only with the DVD-RAM/PD disc cleaner available as an optional accessory.
- Never use cloths or cleaners for CDs, etc.

■ Condensation

Moisture may condense on discs after being brought inside from the cold.

If the disc is a DVD-RAM, use the DVD-RAM/PD disc cleaner available as an optional accessory to wipe it dry.

With other discs, wipe with a soft, dry, lint-free cloth.

■ Handling precautions

- Do not write on the label side with a ball-point pen or other writing instrument.
- Do not use record cleaning sprays, benzine, thinner, static electricity prevention liquids or any other solvent.
- Do not attach labels or stickers to discs. (Do not use discs with exposed adhesive from tape or left over peeled-off stickers.)
- Do not use scratch-proof protectors or covers.
- Do not use discs printed with label printers available on the market.

■ Do not place or store discs in the following places

- Locations exposed to direct sunlight
- Humid or dusty locations
- Locations directly exposed to a heat vent or heating appliance

The remote control

Batteries

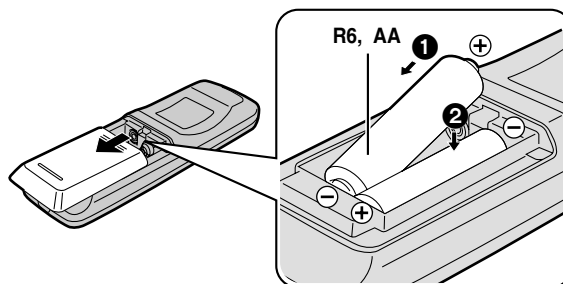

- Insert so the poles (+ and -) match those in the remote control.
- Do not use rechargeable type batteries.

Do not;

- mix old and new batteries.
- use different types at the same time.
- heat or expose to flame.
- take apart or short circuit.
- attempt to recharge alkaline or manganese batteries.
- use batteries if the covering has been peeled off.

Mishandling of batteries can cause electrolyte leakage which can damage items the fluid contacts and may cause a fire.

If electrolyte leaks from the batteries, consult your dealer.

Wash thoroughly with water if electrolyte comes in contact with any part of your body.

Remove if the remote control is not going to be used for a long period of time. Store in a cool, dark place.

Replace if the unit does not respond to the remote control even when held close to the front panel.

Use

Remote control signal sensor

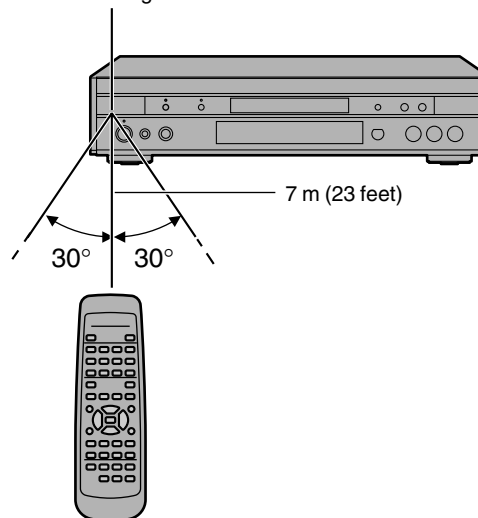

Aim at the sensor, avoiding obstacles, at a maximum range of 7 m (23 feet) directly in front of the unit.

- Keep the transmission window and the unit's sensor free from dust.
- Operation can be affected by strong light sources, such as direct sunlight, and the glass doors on cabinets.

Do not;

- put heavy objects on the remote control.
- take the remote control apart.
- spill liquids onto the remote control.

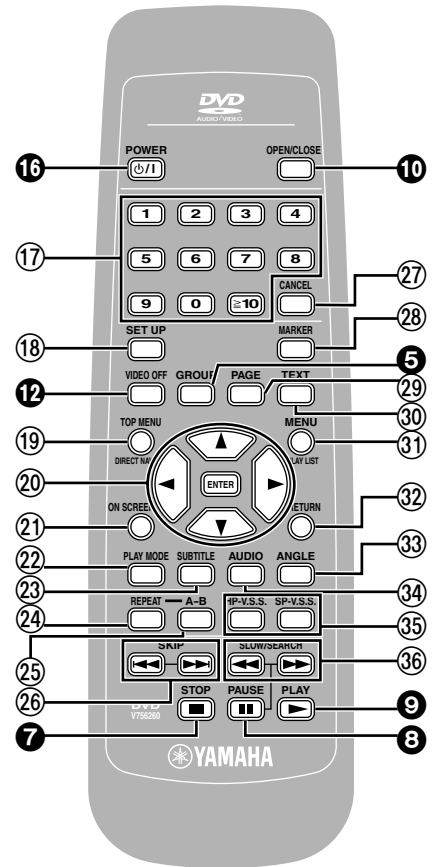
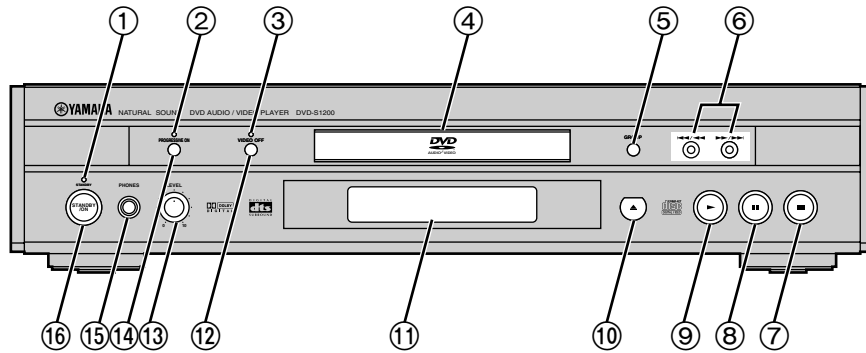

Buttons such as 5 function the same as the controls on the unit.

Main unit

Page

① Standby indicator (STANDBY)	
When the unit is connected to the household AC outlet, this indicator lights up in standby mode and goes out when the unit is turned on.	
② PROGRESSIVE ON indicator (PROGRESSIVE ON)	15
③ VIDEO OFF indicator (VIDEO OFF)	15
④ Disc tray	12
⑤ GROUP button (GROUP)	15
⑥ Skip/Search buttons (I◀◀/◀◀, ▶▶/▶▶I)	14
⑦ Stop button (■)	12
⑧ Pause button ()	12
⑨ Play button (▶)	12
⑩ Disc tray open/close button (▲)	12
⑪ Display	
⑫ VIDEO OFF button (VIDEO OFF)	15
⑬ Headphone level control (LEVEL)	22
⑭ PROGRESSIVE ON button (PROGRESSIVE ON)	15
⑮ Headphone jack	22
⑯ Standby/on switch (STANDBY/ON)	12
Press to switch the unit from on to standby mode or vice versa. In standby mode, the unit is still consuming a small amount of power.	

Remote control

Page

⑰ Numeric buttons (1–9, 0, ≥10)	13
⑱ Set up button (SET UP)	28
⑲ Top menu and Direct Navigator button (TOP MENU, DIRECT NAVI)	13, 19
⑳ Cursor buttons (▲, ▼, ◀, ▶)/Enter button (ENTER)	13
㉑ On screen button (ON SCREEN)	24
㉒ Play mode button (PLAY MODE)	17
㉓ Subtitle button (SUBTITLE)	23
㉔ Repeat mode button (REPEAT)	21
㉕ A-B repeat button (A-B)	21
㉖ Skip buttons (I◀◀, ▶▶I SKIP)	14
㉗ Cancel button (CANCEL)	15
㉘ Marker button (MARKER)	16
㉙ Page button (PAGE)	15
㉚ Text button (TEXT)	12
㉛ Menu and Play List button (MENU, PLAY LIST)	13, 20
㉜ Return button (RETURN)	24, 28
㉝ Angle button (ANGLE)	23
㉞ Audio button (AUDIO)	23
㉟ Headphone and Speaker V.S.S. buttons (HP-V.S.S./SP-V.S.S.)	22
㊱ Slow/Search buttons (◀◀, ▶▶ SLOW/SEARCH)	14

Connection

As this unit has built-in Dolby Digital and DTS decoders (➔ page 34), you can enjoy discs recorded with these systems by connecting this unit to the 6-channel input terminals on an AV amplifier (connection **B** below). However, to enjoy the special sound effects available with AV amplifiers that can make you feel like you were in a cinema or hall, connect this unit digitally to the AV amplifier (connection **A** below).

Use analog connection **B to enjoy the high quality audio (sampling frequencies of 192 kHz and 96 kHz) and multi-channel audio found on DVD-Audio. If the disc is copyright-protected, the audio can only be output through the digital output terminal if it is converted to 48 kHz.**

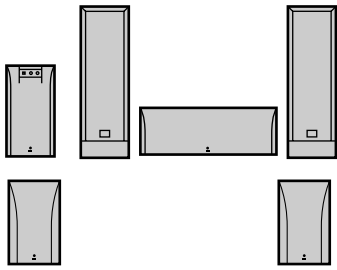
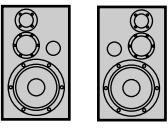
What you want to do	How to do it	Reference page	Settings	Reference page
To enjoy 5.1-channel surround sound 	Digital connection Connect to an amplifier with built-in decoder or a separate decoder-amplifier combination.	9 A	Digital Audio Output Select "On".	29
	Analog connection Connect to an amplifier with 5.1-channel audio input terminals.	10 B	PCM Down Conversion Dolby Digital DTS Digital Surround Change the settings to suit the equipment you connect.	33
To enjoy stereo 	Digital connection Connect to an amplifier with a digital input terminal.	9 C	Digital Audio Output Select "On".	29
	Analog connection Connect to an amplifier or system component with analog input terminals.	10 D	PCM Down Conversion Dolby Digital and DTS Digital Surround Select "PCM".	33

Other uses

Recording to MDs or cassette tapes (➔ page 11).

Note

- The equipment connections described are examples.
- Peripheral equipment and optional cables sold separately unless otherwise indicated.
- Before connection, turn off all equipment and read the appropriate operating instructions.

Manufactured under license from Dolby Laboratories. "Dolby", "Pro Logic" and the double-D symbol are trademarks of Dolby Laboratories. Confidential unpublished works. © 1992–1997 Dolby Laboratories. All rights reserved.

Manufactured under license from Digital Theater Systems, Inc. US Pat. No. 5,451,942, 5,956,674, 5,974,380, 5,978,762 and other world-wide patents issued and pending. "DTS" and "DTS Digital Surround" are registered trademarks of Digital Theater Systems, Inc. © 1996, 2000 Digital Theater Systems, Inc. All rights reserved.

A Connecting an AV amplifier with a built-in decoder

Before connection

- Disconnect the AC power supply cord.
- Refer to the amplifier's operating instructions.

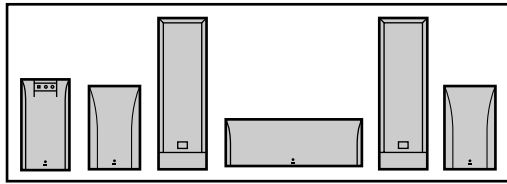
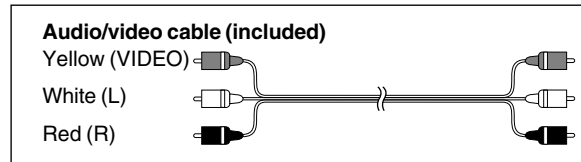

Speakers

You can enjoy surround sound by connecting from three to six speakers.
 Example: Six speakers

If you do not connect a subwoofer, it is advisable to connect main speakers (L/R) capable of producing bass of less than 100 Hz.

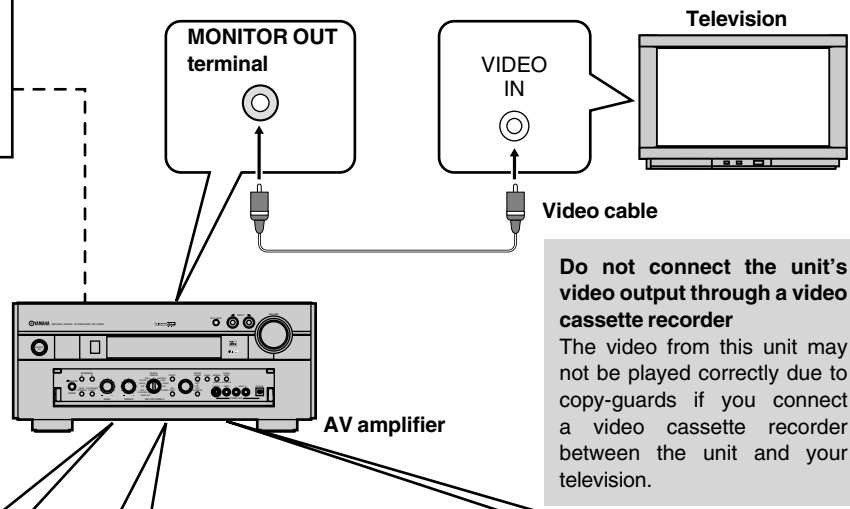

Do not connect the unit's video output through a video cassette recorder
 The video from this unit may not be played correctly due to copy-guards if you connect a video cassette recorder between the unit and your television.

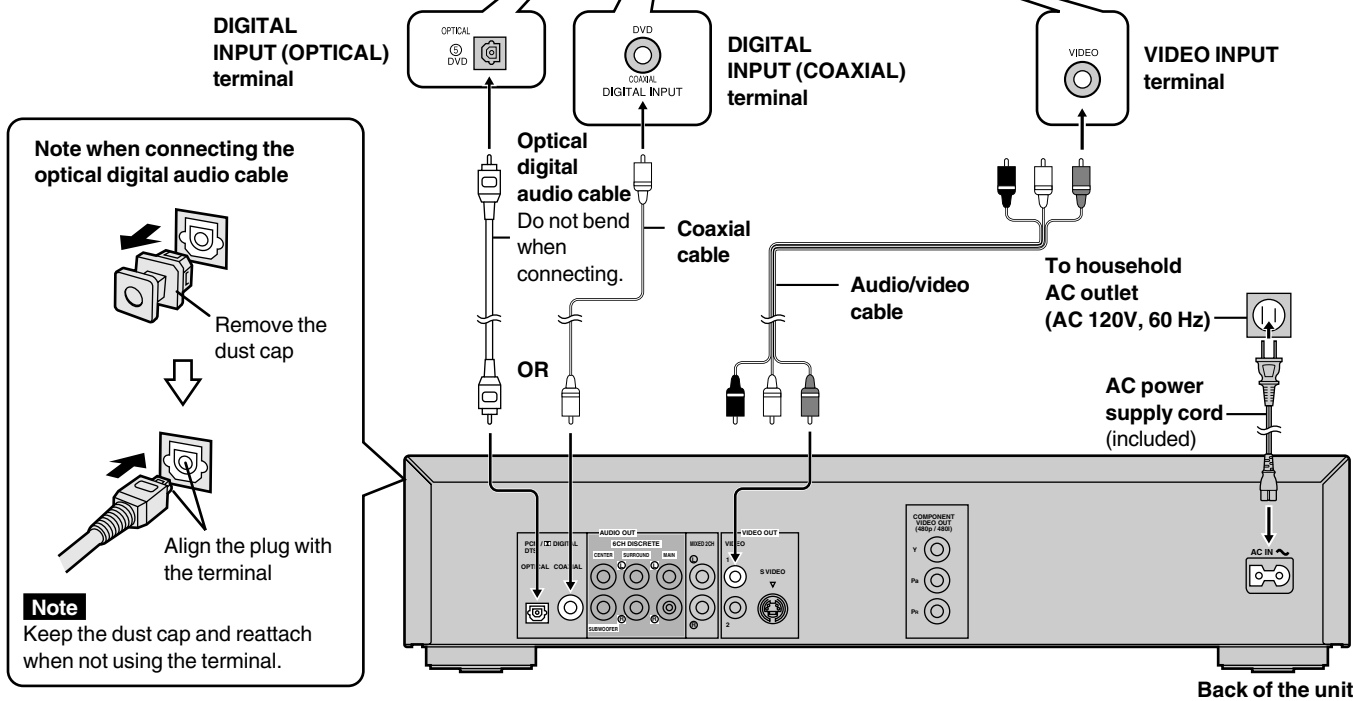

Note when connecting the optical digital audio cable

Remove the dust cap

Align the plug with the terminal

Note
 Keep the dust cap and reattach when not using the terminal.

Change PCM Down Conversion, Dolby Digital, and DTS Digital Surround to suit the equipment (⇒ pages 29 and 33).

Conserving power

This unit consumes a small amount of power, even when it is turned off (approx. 2 W). To save power when the unit is not to be used for a long time, unplug it from the household AC outlet.

Note

You cannot use DTS Digital Surround decoders not suited to DVD-Video.

C Connection to digital audio equipment without a decoder

You can still enjoy audio using the connections described above. Make the following settings (⇒ pages 29 and 33).

- Digital Audio Output ⇒ On
- PCM Down Conversion ⇒ Yes
- Dolby Digital and DTS Digital Surround ⇒ PCM

B Connecting an AV amplifier with 5.1-channel audio input terminals

Be sure to switch the amplifier to ANALOG input.

- Speaker connections (⇒ page 9)
- Television connections (⇒ pages 9 and 11)

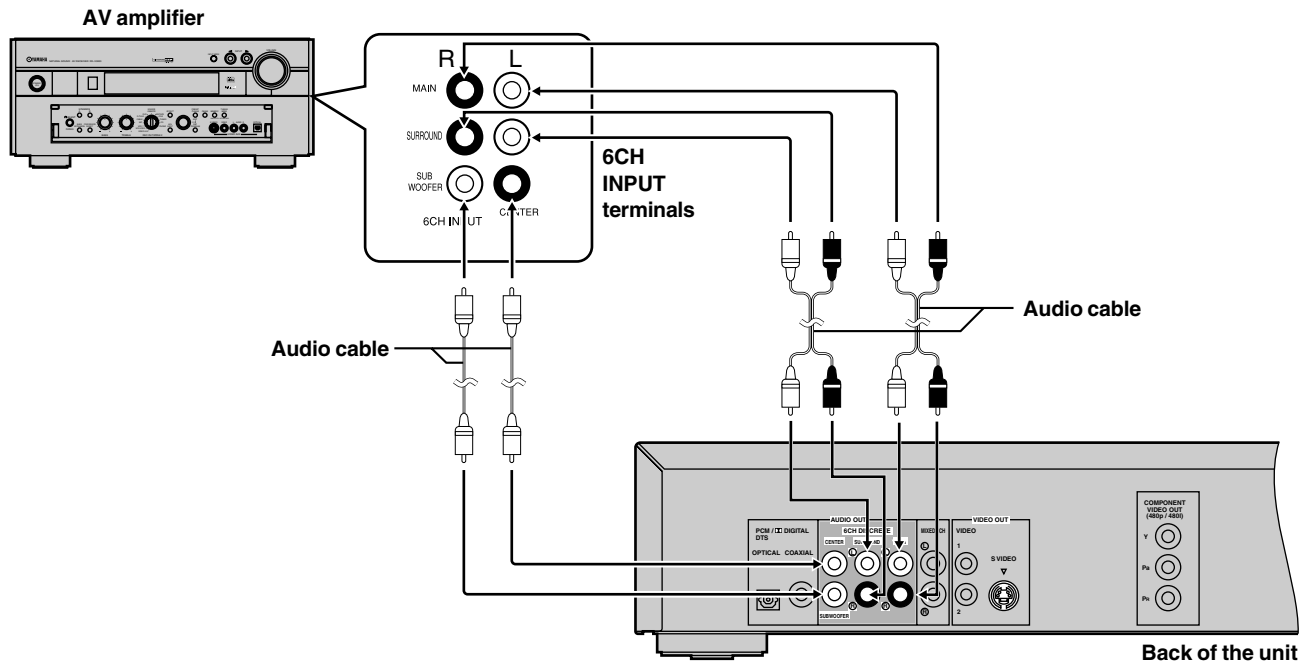

Change "Speaker setting" (⇒ page 32).

Note

- Turn speaker and headphone V.S.S. (⇒ page 22) off when you connect through the 6CH DISCRETE terminals. The unit does not output the signals for channels other than the front speakers when V.S.S. is on.

D Analog connection to a 2-channel amplifier or system component

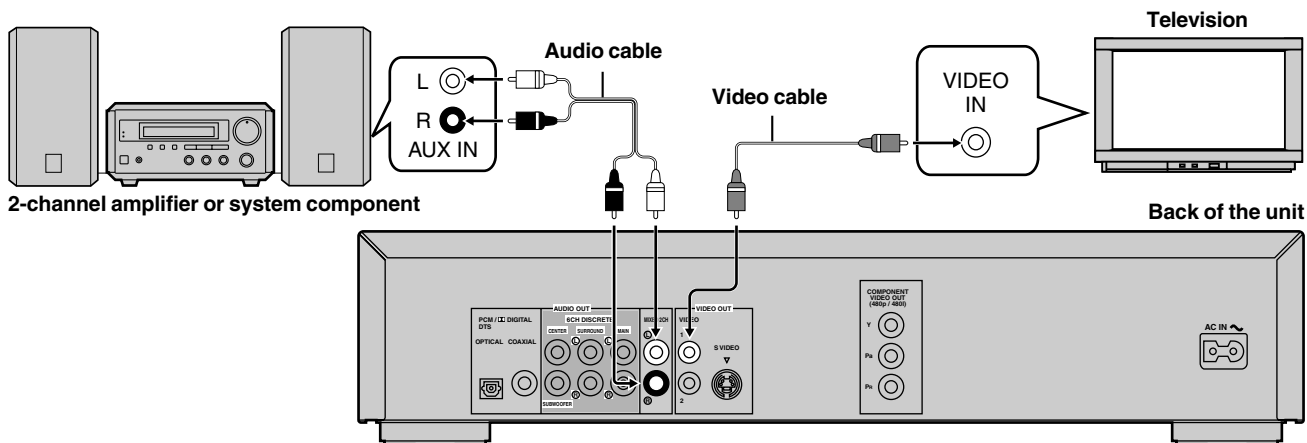

Change PCM Down Conversion, Dolby Digital, and DTS Digital Surround to suit the equipment (⇒ pages 29 and 33).

To enjoy Dolby Pro Logic

- If you connect an amplifier that can decode Dolby Pro Logic, you will also need to connect center and surround speakers to enjoy surround sound. Read the instructions for the equipment for connection details.
- Turn Virtual Surround off (⇒ page 22). Dolby Pro Logic will not function correctly if Virtual Surround is on.

Connections using the S video or component video terminals

Audio connections (⇒ pages 9 and 10)

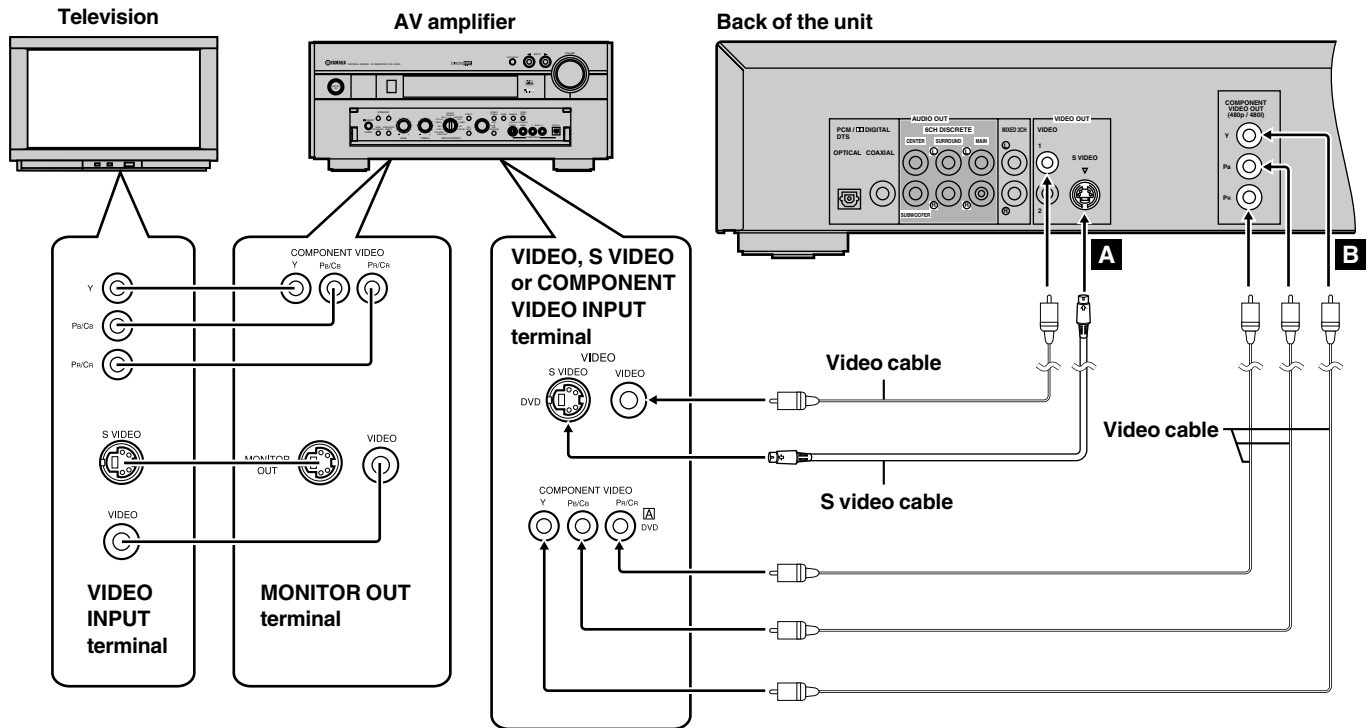

A S VIDEO OUT terminal

The S VIDEO terminal achieves a more vivid picture than the VIDEO terminal by separating the chrominance (C) and luminance (Y) signals. (Actual results depend on the television.)

B COMPONENT VIDEO OUT terminal

These terminals can be used for either interlace or progressive output and provide a purer picture than the S VIDEO terminal.

Connection using these terminals outputs the color difference signals (Pb/Pb) and luminance signal (Y) separately in order to achieve high fidelity in reproducing colors.

- The description of the component video input terminals depends on the television or monitor (e.g. Y/Pb/Pb, Y/B-Y/R-Y, Y/Cb/Cr). Connect to terminals of the same color.
- After making this connection, change the black level for a better picture (⇒ page 29, Video—Black Level Control).

To enjoy progressive video

1. Connect to the component video (480p) input terminals on a television compatible with this unit's copy guard system. Video will not be displayed correctly if you connect to a television that is incompatible with this unit's copy guard system.
2. Press [PROGRESSIVE ON] on the front panel so the indicator lights (⇒ page 15).

Recording to MDs or cassette tapes

■ Analog recording

You can record to an MD or cassette deck. Using analog connection means sound will be unaffected by the copy guards found on DVDs.

To make an analog recording

Connect the recording equipment with an audio cable (⇒ page 10 D).

■ Digital recording

You can record the digital signal directly onto an MD.

The signals on DVDs will be converted to 48 kHz/16 bit linear PCM. Ensure the following conditions are met.

- There is no copy guard recorded on the disc.
- The recording equipment can handle a sampling frequency of 48 kHz/16 bit.

To make a digital recording

1. Connect the recording equipment with an optical or coaxial digital audio cable (⇒ page 9 A).
2. When recording DVDs, make the following settings.
 VIRTUAL SURROUND (V.S.S.): OFF (⇒ page 22)
 Digital Audio Output: On (⇒ page 29)
 PCM Down Conversion: Yes (⇒ page 29)
 Dolby Digital and DTS Digital Surround: PCM (⇒ page 29)

Basic play

RAM DVD-A DVD-V VCD CD

Preparation

Turn on the television and select the appropriate video input on the television to suit the connections for the player.

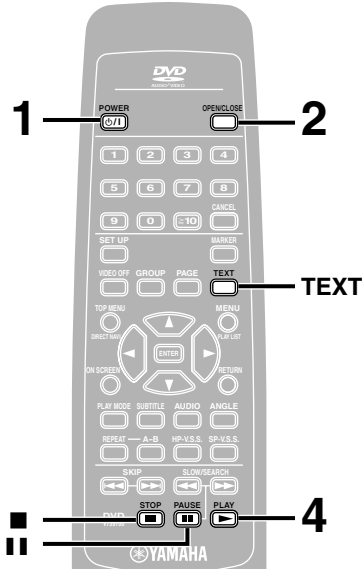
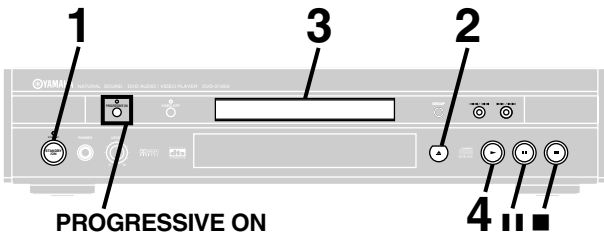

1 Press [POWER] to turn on the unit.

For progressive output

Press [PROGRESSIVE ON] so the indicator lights.

2 Press [OPEN/CLOSE] to open the disc tray.

3 Place the disc on the disc tray.

Remove TYPE 2 discs from their cartridges before use.

4 Press [PLAY].

The disc tray closes and play begins.

To stop play

Press [STOP] (→ page 13, Resume function).

To pause play **A**

Press [PAUSE] during play.

Press [PLAY] (PLAY) to restart play.

Displaying the text information on discs

DVD-A DVD-V CD

Remote control only

You can display the disc title, artist name, and track titles on the television if this information is recorded on the disc.

Press [TEXT].

The text display is turned on and off each time you press the button. Some text information also scrolls across the unit's display.

- The unit cannot display the text on some discs.

Playing CD-R and CD-RW

This unit can play CD-DA (digital audio) and Video CD format audio CD-R and CD-RW that have been finalized* upon completion of recording.

It may not be able to play some CD-R or CD-RW due to the condition of the recording.

*Finalizing is a process that enables CD-R/CD-RW players to play audio CD-R and CD-RW.

Note

- If "⊘" appears on the television

The operation is prohibited by the unit or disc.

- The disc continues to rotate while the menu is displayed even after you finish playing an item. Press [STOP] when you finish to preserve the unit's motor and your television screen.

- Volume may be lower when playing DVDs than when playing other discs or during television broadcasts.

If you turn the volume up on the television or amplifier, ensure you reduce the volume again before playing other sources so that a sudden increase in output does not occur.

Auto standby

The unit switches to the standby mode after about 30 minutes in the stop mode.

1 POWER



2 OPEN/CLOSE

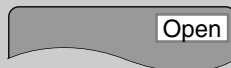
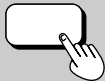

3

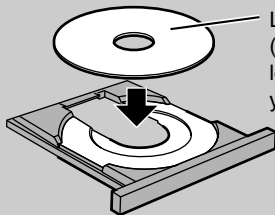

Label must face upward.
(With double-sided discs,
load so the label for the side
you want to play is facing up.)

4 PLAY

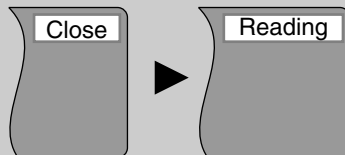

Unit's display (e.g. DVD-Video is loaded)



A PAUSE



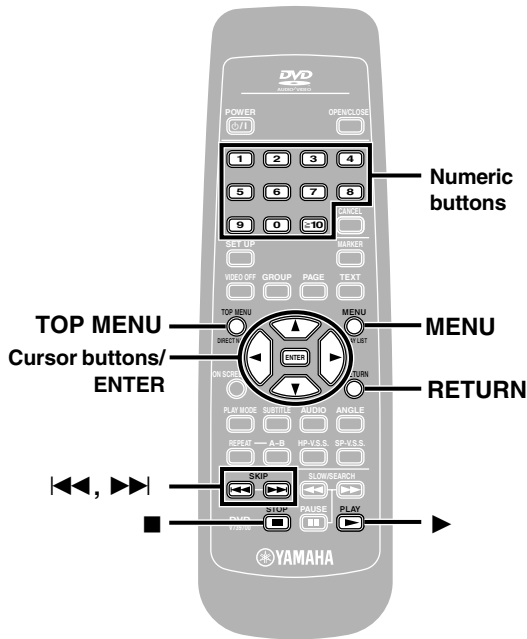
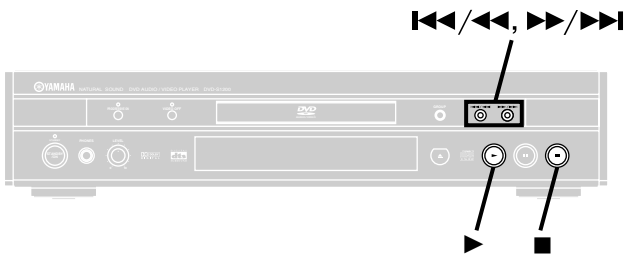

When a menu screen appears on the television

DVD-A DVD-V VCD

Remote control only

Press the numeric buttons to select an item.

To select a 2-digit number

Example: To select item 23, press ≥ 10 \Rightarrow [2] \Rightarrow [3].

•When playing DVDs, you can also use the cursor buttons [\blacktriangle , \blacktriangledown , \blacktriangleleft , \blacktriangleright] to select items. Press [ENTER] to confirm your selection.

Play of the selected item now begins.

Other buttons used to operate menus

Read the disc's instructions for further details about operation.

[\blacktriangleright] or [\blacktriangleright / \blacktriangleright]: Shows the next menu.

[\blacktriangleleft] or [\blacktriangleleft / \blacktriangleleft]: Shows the previous menu.

[RETURN]: Shows the menu screen. **VCD**

[TOP MENU]: Shows the first menu screen. **DVD-A DVD-V**

[MENU]: Shows the menu screen. **DVD-V**

A DVD menus

DVD-Video can have several menus. The menu displayed when you press [TOP MENU] may be different from the menu displayed when you press [MENU].

B Resume function

RAM DVD-A DVD-V VCD CD

The position you stopped play at is recorded by the unit when " \triangleright " is flashing on the unit's display.

While " \triangleright " is flashing on the unit's display, press [\blacktriangleright] (PLAY) to start play from where you stopped it.

If you are playing DVD-Video, the illustrated message also appears. Press [\blacktriangleright] (PLAY) while the message is displayed and the beginning portions of each chapter up to the current one are played. Full play resumes from the point where you stopped play. (This feature works only within a title.)

If you do not press [\blacktriangleright] (PLAY), the message disappears and play starts from where you stopped it.

To cancel

Press [\blacksquare] until " \triangleright " disappears from the unit's display.

Note

- The resume function does not work if the disc's play time is not displayed.
- The position is cleared when the disc tray is opened.
- The unit saves the position even when you switch the unit to standby except when playing a play list (\Rightarrow page 20).

C Starting play from a selected program, title, or track

RAM DVD-A DVD-V VCD CD

Remote control only

Press the numeric buttons to select the item.

To select a 2-digit number

Example: To select track 23, press ≥ 10 \Rightarrow [2] \Rightarrow [3].

Play starts from the selected item.

Note

- This works only when stopped with some discs.
- This may not work with some discs.
- When playing DVD-Audio and you want to start play from a track in a different group, select the group first (\Rightarrow page 15).

A

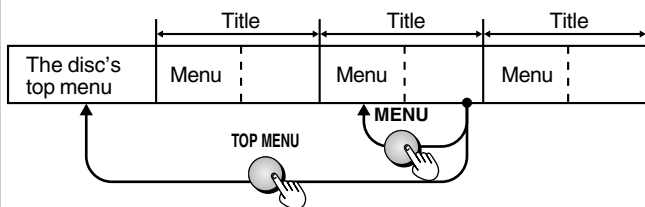

B



Press PLAY to Chapter Review

C

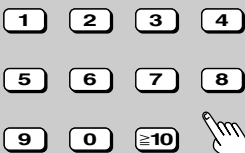

e.g. Video CD

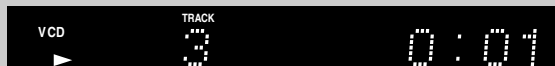

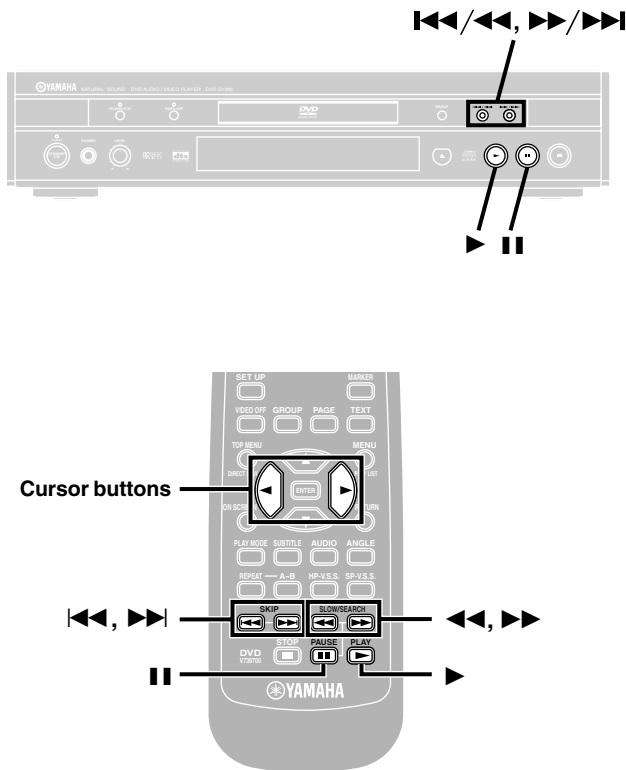

Basic play

A Skipping

RAM DVD-A DVD-V VCD CD

You can skip chapters on DVD-Video, tracks on DVD-Audio, CDs, and Video CDs, and on DVD-RAM you can skip to the start of a program, scene in a play list, or to a marker.

During play or while paused

Press [⏮] or [⏭].

- Each press increases the number of skips.
- Press [⏮/⏮] or [⏭/⏭] on the main unit.

B Frame-by-frame viewing

RAM DVD-A DVD-V VCD

Remote control only

While paused

Press the cursor buttons [◀] or [▶].

The frame changes each time you press the cursor buttons.

- The frames change in succession if you press and hold the button.
- Pressing [⏭] also activates forward frame-by-frame.

C Fast forward and rewind—SEARCH

RAM DVD-A DVD-V VCD CD

During play

Press [⏮] or [⏭].

Press and hold [⏮/⏮] or [⏭/⏭] on the main unit.

For your reference

Audio will be heard during search for most discs. You can turn this audio off if you want to (➡ page 29, Audio—Audio during Search).

D Slow-motion play

RAM DVD-A DVD-V VCD

While paused

Press [⏮] or [⏭].

Press and hold [⏮/⏮] or [⏭/⏭] on the main unit.

Notes

- The speed of search and slow-motion increases up to 5 steps.
- Press [▶] (PLAY) to restart play.
- You cannot move backwards with Video CD during frame-by-frame and slow-motion.
- Frame-by-frame and slow motion only work on the moving picture parts of DVD-Audio.
- [⏮/⏮], [◀] or [⏮]: Backward
[⏭/⏭], [▶] or [⏭]: Forward

When playing Video CDs with playback control

Pressing buttons to perform skipping, search, or slow-motion may take you to a menu screen.

A

SKIP

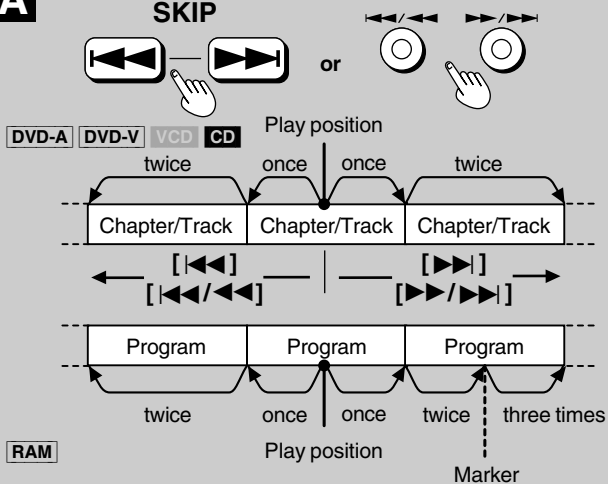

B

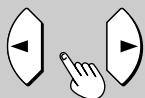

C

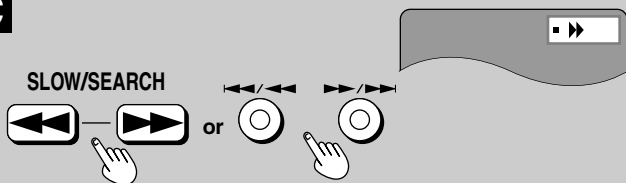

D

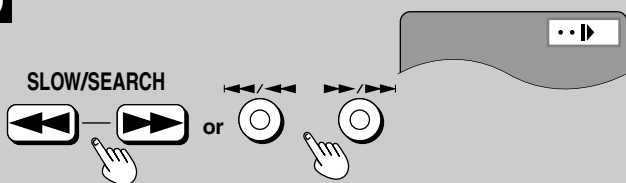

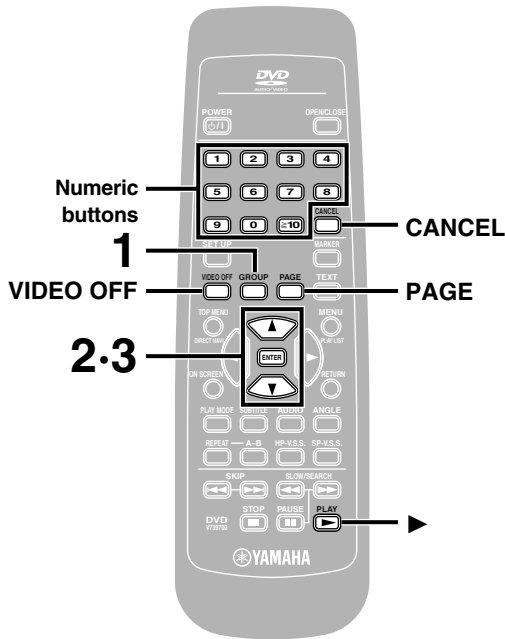
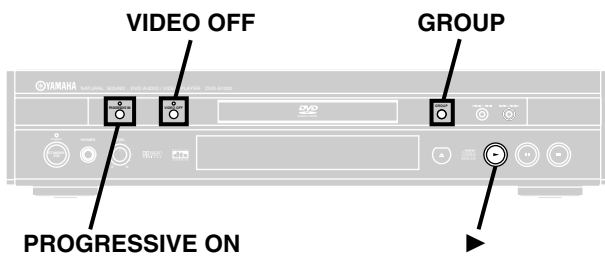

Basic play

A Selecting still pictures—Page Skip

DVD-A

Remote control only

During play

Press [PAGE].

The page changes each time you press the button.

B Selecting groups to play

DVD-A

The tracks on DVD-Audio are divided into groups. How these groups are played differs with the disc so read the instructions that came with the disc for further details.

1 Press [GROUP].

The group and track icons are displayed.

2 Press the cursor buttons [▲, ▼] to select the group number and press [ENTER].

3 Press the cursor buttons [▲, ▼] to select the track number and press [ENTER].

The selected group and track begin to play.

- You can also select groups with the remote control's numeric buttons or [GROUP] on the main unit. Press [▶] (play) to start playing the selected group.
- Selection may not be allowed in some situations.

Playing all the groups in succession (▶ page 17)

Playing bonus groups

Some discs contain bonus groups. To enjoy these groups you may have to enter a password. Refer to the disc's jacket.

1. While stopped press [GROUP].
2. Press the cursor buttons [▲, ▼] to select the bonus group and press [ENTER].
3. Enter the 4-digit password with the remote control's numeric buttons and press [ENTER].
4. Press the cursor buttons [▲, ▼] to select a track and press [ENTER] to start play.

- Some discs will show a menu screen for you to enter your password. Follow the instructions on the screen.

- The bonus group can be played as many times as you like after the password has been entered until the disc is removed from the unit.

Note

If you enter the wrong password, the previous screen will be displayed. Start again from the beginning. You can erase it by pressing [CANCEL].

C To enjoy even higher quality sound—VIDEO OFF

RAM DVD-A DVD-V VCD CD

You can enjoy higher quality audio by stopping the video signal.

Press [VIDEO OFF].

- The light above the button on the main unit lights.
- VIDEO OFF is canceled if you press the button again or turn the unit off. The light goes out.

Note

Video signals are output while the disc is stopped and when operations such as searching are performed. The television can appear unusual while video signals are not being output.

D To enjoy even higher quality picture—PROGRESSIVE ON

RAM DVD-A DVD-V VCD

The component video output terminals (Y, P_B/C_B, P_R/C_R) can output progressive signals. You can obtain a sharp and smooth high-quality picture with less flicker using a television that can receive progressive signals. (▶ page 11)

Press [PROGRESSIVE ON].

- The PROGRESSIVE ON indicator lights.
- PROGRESSIVE ON is canceled if you press the button again. The indicator goes out.

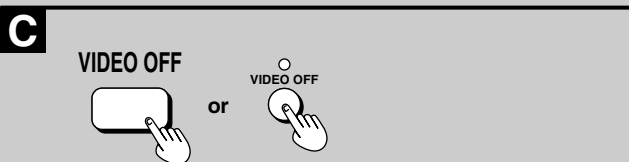
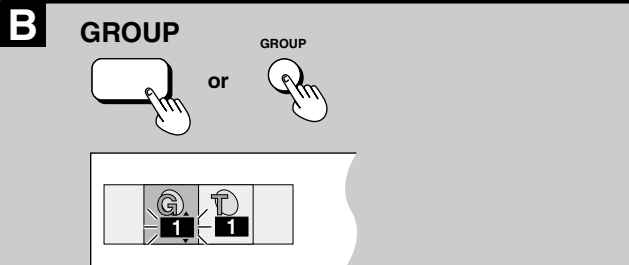
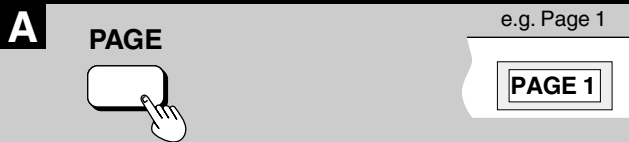

Marking places to play again—MARKER

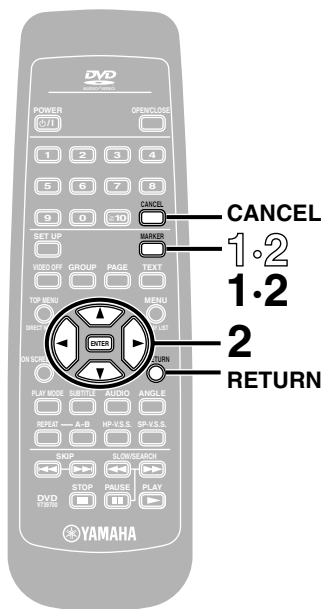

Remote control only

You can mark specific points on a disc to return to later. This feature only works if the elapsed playing time of the disc is shown on the unit's display.

DVD-A DVD-V VCD CD

- 1 Press [MARKER].**
The marker icon appears.
- 2 Press [MARKER] at the point you want to mark.**
To select another marker, press the cursor button [▶].
You can mark up to 5 points.

RAM

You can mark up to 999 points.

- 1 Press [MARKER].**
The marker icon appears and if the disc already has markers, they are displayed.
- 2 Press the cursor button [▶] to highlight the first marker, then press [MARKER] at the point you want to mark.**

1 **MARKER**

2 **MARKER**

1 **MARKER**

2

MARKER

To mark the eleventh point and beyond

Select the next group of 10 as follows.

1. Press the cursor button [◀, ▶] to highlight the marker pin icon.

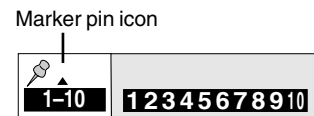

2. Press the cursor button [▲] to select "11-20".



You can select the next group of 10 when the current group is full.

To clear the marker display

Press [RETURN].

To play from a marked position

Press the cursor button [◀, ▶] to select a marker number and press [ENTER].

To clear a marker

Press the cursor button [◀, ▶] to select a marker number and press [CANCEL].

- You can clear existing markers, but they are restored when you open the disc tray or switch the unit to standby.

Note

- All the markers added with this unit are cleared when the unit is switched to standby or the disc tray is opened.

RAM

- This feature doesn't work while using a play list.
- The markers are ordered by time. This means that the marker numbers can change when you add and erase markers.

Changing the play sequence

Remote control only

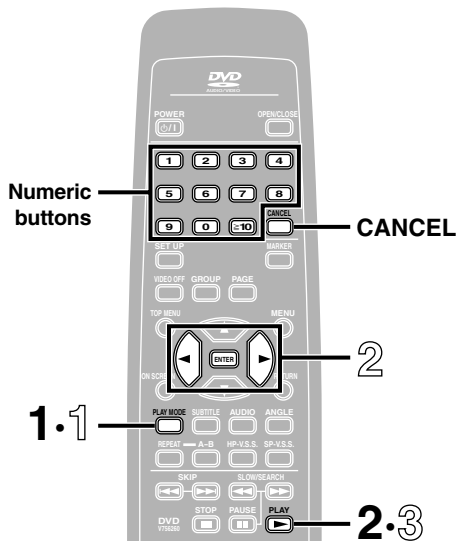

A All group play

DVD-A

The unit plays the tracks in all the groups on a disc.

- 1 While stopped
Press [PLAY MODE] until the all group play screen appears.
- 2 Press [▶] (PLAY).

B Random play

DVD-A VCD CD

The unit plays the tracks on a disc in random order.

- 1 While stopped
Press [PLAY MODE] until the random play screen appears.
- 2 **DVD-Audio only**
Press the cursor buttons [◀, ▶] to select a group and press [ENTER].
 - You can select more than one group.
 - You can also select groups with the numeric buttons.
- 3 Press [▶] (PLAY).
Play now begins in random order.

Advanced operations

A

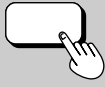
- 1 **PLAY MODE**

All Group Playback
Press PLAY to start

- 2 **PLAY**



B

e.g. DVD-Audio (three groups)

- 1 **PLAY MODE**

Random Playback
Choose a group or groups
All 1 2 3

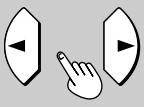
SELECT
ENTER RETURN
Press PLAY to start



- 2

Random Playback
Choose a group or groups
ALL 1 2 3
 *
SELECT
ENTER RETURN
Press PLAY to start



- 3 **PLAY**

To clear a group DVD-A

1. Press the cursor buttons [◀, ▶] to select the group you want to clear.
 2. Press [CANCEL] or [ENTER].
- Groups can also be erased by entering the group number with the numeric buttons.

To exit random mode

Press [PLAY MODE] while stopped until the random play screen disappears.

Note

If you select bonus groups on DVD-Audio during random play, you will have to enter a 4-digit password (➔ page 15).

DVD-A VCD CD

Remote control only

Program play

You can select up to 32 tracks to play in the order you choose.

- 1 While stopped
Press [PLAY MODE] until the program play screen appears.
- 2 Press [ENTER].
- 3 **DVD-Audio only**
Press the cursor buttons [▲, ▼] to select a group and press [ENTER].
- 4 Press the cursor buttons [▲, ▼] to select a track and press [ENTER].
Each time you press the cursor button,
1 ↔ 2 ← ----- → ALL
↑

 - Repeat steps 2, 3 and 4 to program other tracks.
 - You can also select a group or track with the numeric buttons.
 - "Total Time" tells you the total time of the programmed tracks.
 - All the tracks on a disc are selected when you select "ALL" (all the tracks in the selected group with DVD-Audio).

- 5 Press [▶] (PLAY).
Play now begins in the programmed sequence.

To add or change tracks

1. Press the cursor buttons [▲, ▼] to select an available item.
2. Repeat steps 2–4 to make the changes.

To move to the page before or after the one shown

Press [◀◀] or [▶▶].

To clear the programmed tracks one by one

Press the cursor buttons [▲, ▼] to select the item number (No) and press [CANCEL]. Alternatively, press the cursor buttons [▲, ▼, ◀, ▶] to select "Clear" and press [ENTER].

To clear the whole program

Press the cursor buttons [▲, ▼, ◀, ▶] to select "Clear all" and press [ENTER].

The whole program is also cleared when the unit is turned off, or the disc tray is opened.

To exit the program mode

Press [PLAY MODE] while stopped until the program play screen disappears.

- The program is retained in memory.

Note

If you select bonus groups on DVD-Audio during program play, you will have to enter a 4-digit password (➔ page 15).

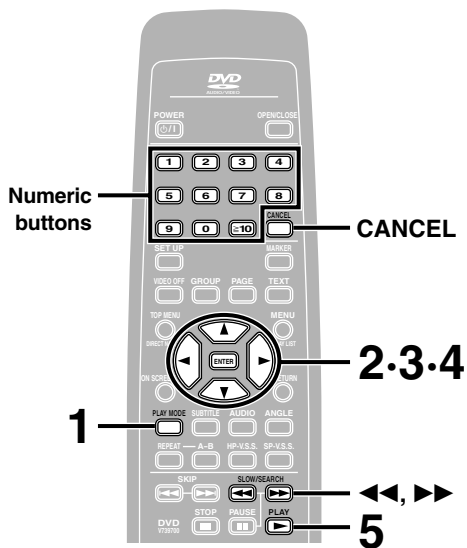

1 PLAY MODE

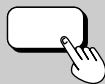

e.g. DVD-Audio

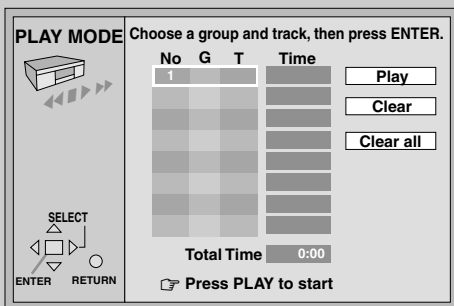

2 ENTER

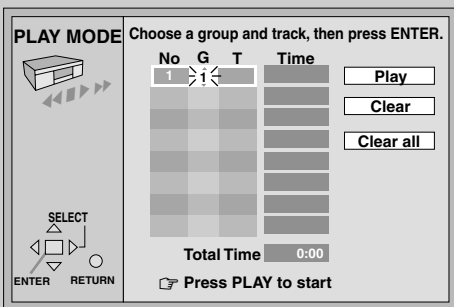

3.4

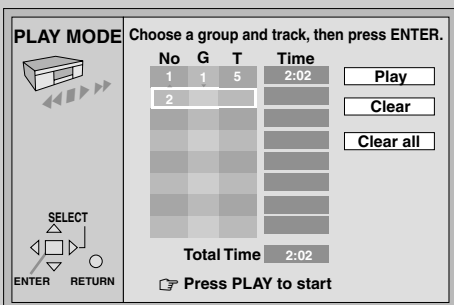

5 PLAY



Playing the programs on DVD-RAM

RAM

Remote control only

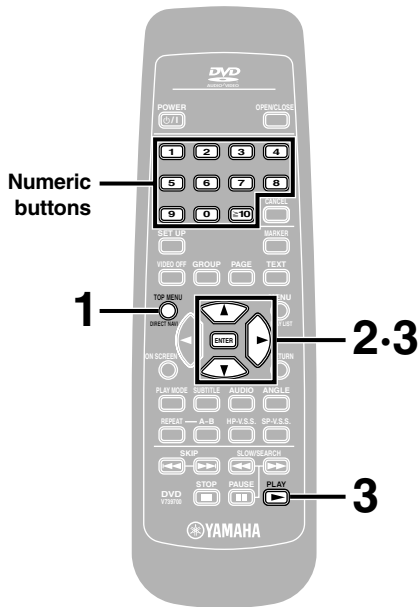

Selecting programs to play— DIRECT NAVIGATOR

When a program list is recorded on the disc, you can use it to find programs you want to watch and start play.

- 1 Press [DIRECT NAVI].**
The program list is displayed and the program currently selected plays in the background.
- 2 Press the cursor buttons [▲, ▼] to select the program you want to watch.**
You can also select a program with the numeric buttons. Step 3 is unnecessary.

To enter a 2-digit number

Example: 17, press, [≧10] → [1] → [7].

- 3 Press [▶] (PLAY).**
Play starts from the beginning of the selected program.
By pressing [ENTER] instead of [▶] (PLAY) play of the program that was playing in the background continues.

1

TOP MENU



DIRECT NAVI

DIRECT NAVIGATOR					
No	DATE	CH	On	Program Title	Contents
1	12/23(SAT)	10	21:02	Saturday feature	[SEE]
2	12/26(TUE)	4	14:35	Auto action	[SEE]
3	1/12(FRI)	2	20:00	Sunday Cinema	[SEE]
4	1/24(WED)	5	19:30	Music	[SEE]
5	2/20(TUE)	12	19:05	Baseball	[SEE]

SELECT ▲
ENTER ▼ RETURN ○

2

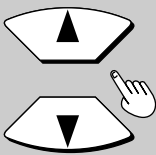

e.g. when program 2 has been selected.

DIRECT NAVIGATOR					
No	DATE	CH	On	Program Title	Contents
1	12/23(SAT)	10	21:02	Saturday feature	[SEE]
2	12/26(TUE)	4	14:35	Auto action	[SEE]
3	1/12(FRI)	2	20:00	Sunday Cinema	[SEE]
4	1/24(WED)	5	19:30	Music	[SEE]
5	2/20(TUE)	12	19:05	Baseball	[SEE]

SELECT ▲
ENTER ▼ RETURN ○

3

PLAY



To clear the program list

Press [DIRECT NAVI].

(The unit returns to the condition it was in before you called up the program list.)

To display information about a selected program

1. Do steps 1 and 2 to select the program, then press the cursor button [▶] to select "Contents" on the right side of the list.
2. Press [ENTER].

The background picture pauses. Press [ENTER] to return to the program list.

If there are 6 or more programs

Press the cursor button [▼] while program 5 is highlighted.

The programs not currently shown are displayed each time you press the cursor button.

For your reference

- Program and disc titles are displayed only if they have been entered.
- You cannot change program and disc titles.

RAM

Remote control only

Using the play list menu to play specific scenes

Finding and playing particular scenes is simple if the disc has play lists recorded on it.

- 1 Press [PLAY LIST].**
The play list screen is displayed.
- 2 Press the cursor buttons [▲, ▼] to select the play list you want to watch.**
• If you press [ENTER] or select a play list with the numeric buttons, all the scenes in the play list are played from the beginning.
- 3 Press the cursor button [▶] to select “Contents” on the right side of the list and press [ENTER].**
- 4 Press the cursor buttons [▲, ▼] to select “Scene List” and press [ENTER].**
- 5 Press the cursor buttons [▲, ▼, ◀, ▶] to select the scene you want to watch and press [ENTER].**

- The scene starts playing.
- You cannot move the highlighting to places where a scene is not displayed.
 - If there are more than 9 scenes in the play list, press the cursor buttons [▲, ▼, ◀, ▶] to select “Next” and press [ENTER]. You can move back to the previous page by selecting “Prev”.
 - You can also select a page of play list scenes by entering the page number with the numeric buttons. (The page numbers appear at the bottom center of the screen.)

To enter a number

Example: 17, press, [1] ⇒ [7] ⇒ [ENTER].

Example: 111, press, [1] ⇒ [1] ⇒ [1] ⇒ [ENTER].

To display information about a selected play list

1. Do steps 1 and 2 to select the play list.
2. Press the cursor button [▶] to select “Contents” on the right side of the list and press [ENTER].
3. Press the cursor buttons [▲, ▼] to select “Program contents” and press [ENTER].

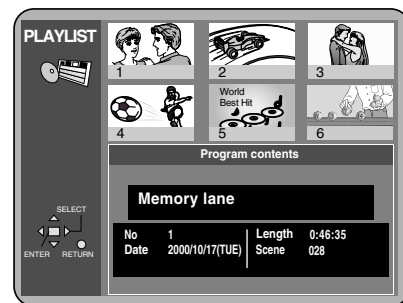

When play finishes

- After playing a play list: the play list selection screen appears.
- After playing a scene: the scene selection screen appears.

To return to the previous screen

Press [RETURN].

To clear the play list screen

Press [PLAY LIST].

The unit returns to the condition it was in before you called up the play list.

To stop play list play

Press [■] until the screens clear.

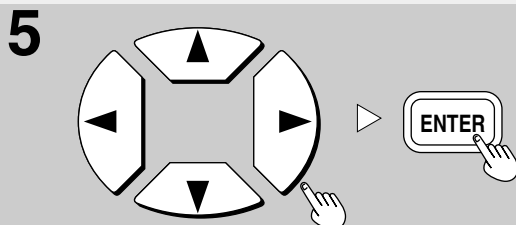
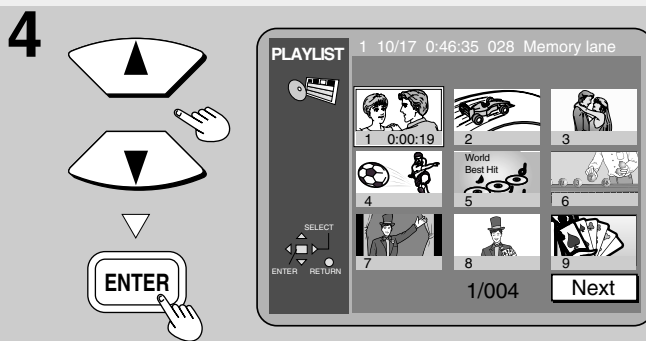
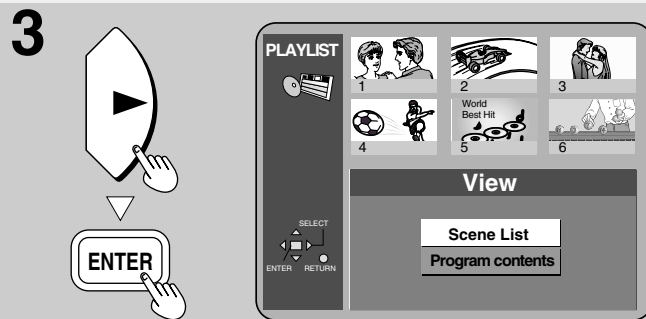
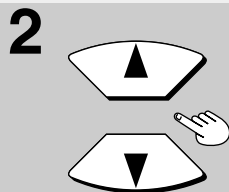
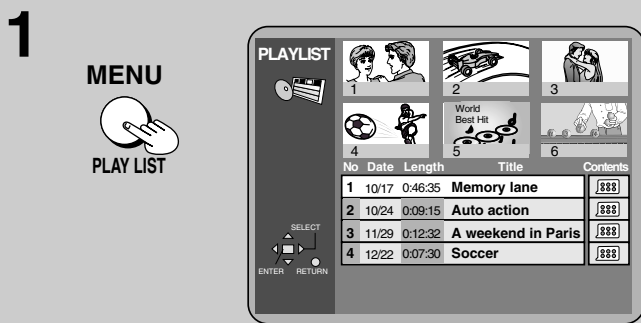
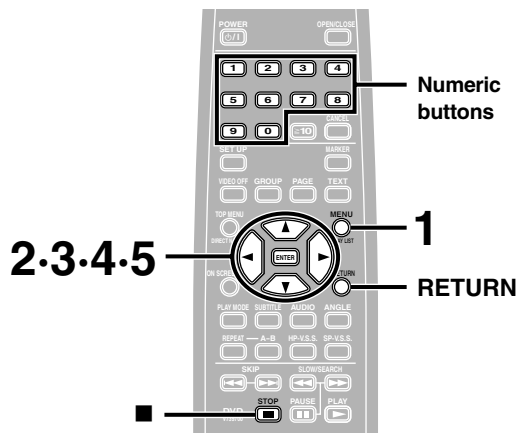

Repeat play

RAM DVD-A DVD-V VCD CD

Remote control only

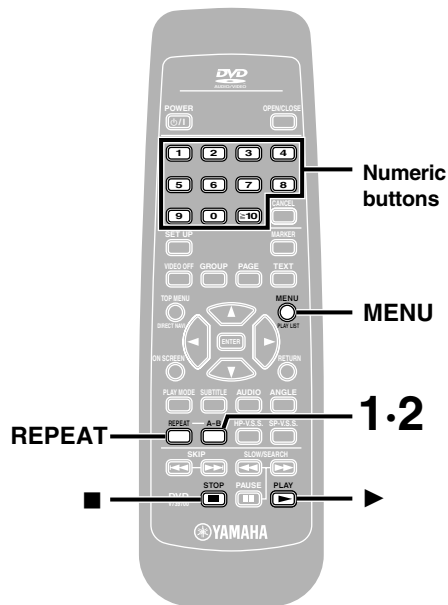

A Repeat play

During play

Press [REPEAT].

The display changes as illustrated.

•DVD-RAM

Program (PG) → Entire disc (A) → OFF

While playing a playlist

Scene (S) → Play list (PL) → OFF

“PL” is not displayed while playing a specific play list scene.

•DVD-Audio

Track (T) → Whole group (G) → OFF

During All group, Program, or Random play modes, “A” is displayed instead of “G”.

•DVD-Video

Chapter (C) → Title (T) → OFF

•Video CD/CD

Track (T) → Entire disc (A) → OFF

A REPEAT



e.g. DVD-Video

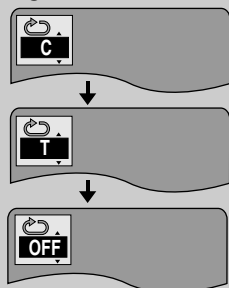

B A-B

1

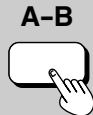

2

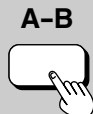

B A-B repeat play

You can repeat a section between points A and B within a program, title, or track.

1

During play

Press [A-B] at the starting point (A).

2

Press [A-B] at the finishing point (B).

To cancel

Press [A-B] until “” is displayed.

Note

- A-B repeat does not work if the DVD's elapsed play time is not shown on the unit's display.
- Some subtitles recorded around point A or B may fail to appear.
- The unit automatically determines the end of a program/title/track as point B when the end of the program/title/track is reached.

Increasing your enjoyment of movies and music

A Enjoying virtual surround effects with 2 speakers or headphones (VIRTUAL SURROUND (V.S.S.))

RAM DVD-V VCD

SP-V.S.S.: Dolby Digital, DTS, MPEG, LPCM, 2-channel or over only

HP-V.S.S.: Dolby Digital, MPEG, LPCM, 2-channel or over only

Remote control only

Use VIRTUAL SURROUND (V.S.S.) (Virtual Surround Sound) to enjoy a surround-like effect if you are using two front speakers or headphones.

If you are playing a disc with surround effects recorded on it, the effect is broadened and sound seems to come from virtual speakers on either side.

During play

Press [SP-V.S.S.] or [HP-V.S.S.].

Each time you press the button:

SP 1/HP 1: Natural effect → SP 2/HP 2: Emphasized effect

← SP OFF/HP OFF: Cancel ←

Note

- Virtual Surround will not work, or will have less effect, with some discs, even if you select "1" or "2".
- Turn off the surround sound effects on the equipment you have connected when using this effect.
- Turn Virtual Surround off if it causes distortion.
- Output from this unit will be in stereo (two channels) when V.S.S. is on.

B Using headphones

- 1 Set [LEVEL] to "0" and connect the headphones (not included).
- 2 Adjust headphone volume with [LEVEL].

Note

Avoid listening for prolonged periods of time to prevent hearing damage.

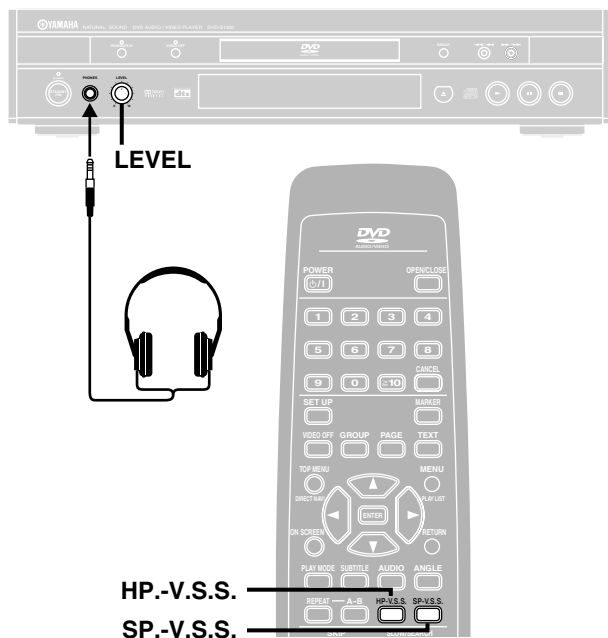

HP-V.S.S.

SP-V.S.S.

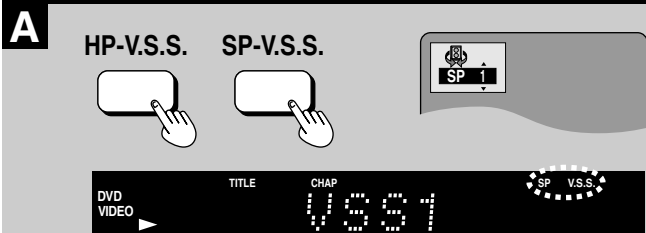

Optimum seating position

<When using the television's speakers>
Distance A =
Television's width

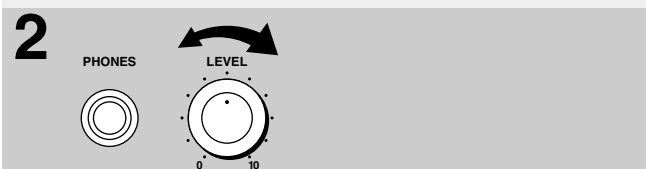
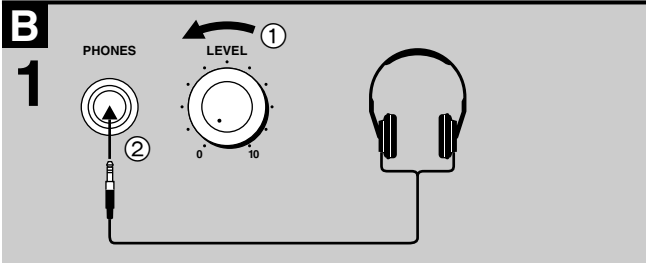
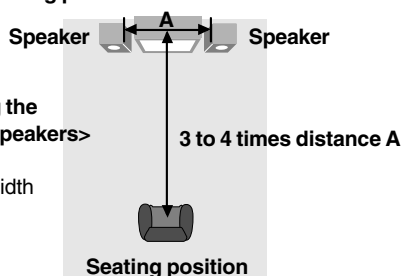

Changing soundtracks, subtitle languages and angles

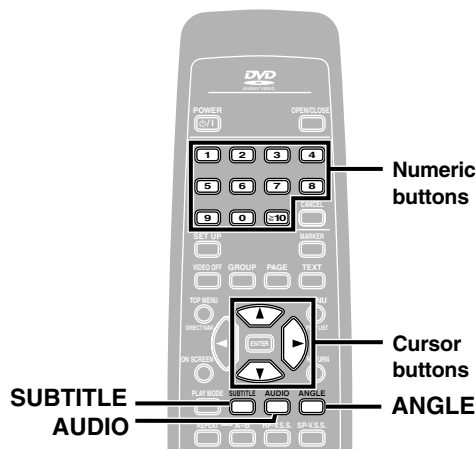

Remote control only

Some DVDs have multiple soundtracks, subtitle languages and camera angles, and you can change these during play.

A Soundtracks

RAM DVD-A DVD-V

During play

Press [AUDIO].

The number changes each time you press the button.

- Play restarts from the beginning of the soundtrack when playing DVD-Audio and DVD-RAM soundtracks that are accompanied by still pictures.
- Even if a second soundtrack isn't recorded on a DVD-Audio, two soundtrack numbers will normally be shown when you press [AUDIO]. The soundtrack currently playing is number 1.
- You can also use this button to turn the vocals on and off on karaoke discs. Read the disc's instructions for details.

B Subtitles

RAM DVD-A DVD-V

With DVD-Audio and DVD-Video you can change the subtitle language and turn the subtitles on and off. With DVD-RAM you can turn the subtitles on and off.

During play

Press [SUBTITLE].

The number changes each time you press the button.

To clear/display the subtitles

1. Press [SUBTITLE].
2. Press the cursor button [▶]. (DVD-Audio and DVD-Video only)
3. Press the cursor button [▲, ▼] to select "ON" or "OFF".

C Angles

DVD-A DVD-V

During play

Press [ANGLE].

The number changes each time you press the button.

Notes regarding soundtracks, subtitle languages and angles

- You can also press the cursor button [▲, ▼] or use the numeric buttons to change the soundtracks, subtitle languages and angles.
- Some discs allow changes to soundtracks, subtitle languages and angles only by using the disc's menus.
- Soundtrack and subtitle languages can be set before play (→ page 29, Disc—Audio and Subtitle).
- "—" or "—" is displayed instead of the language number in circumstances such as when no language is recorded on the disc.
- Some discs allow you to set angles before multi-angle scenes are played. Read the instructions that come with the DVD.
- In some cases, the subtitle language is not changed to the selected one immediately.
- If the subtitles overlap closed captions recorded on discs, turn the subtitles off.

A AUDIO



DVD-Audio

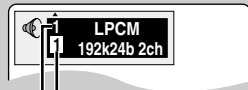

Soundtrack selected

Soundtrack playing

DVD-Video

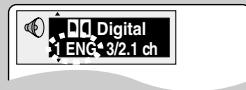

Indicates that a multi-channel soundtrack can be down-mixed. Lights when a multi-channel soundtrack is playing.

e.g. DVD-Video

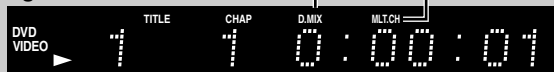

B SUBTITLE



DVD-Video



Subtitle language number



C ANGLE

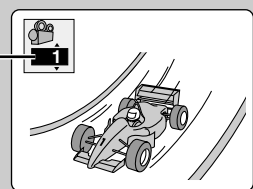

Angle number

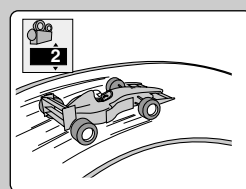

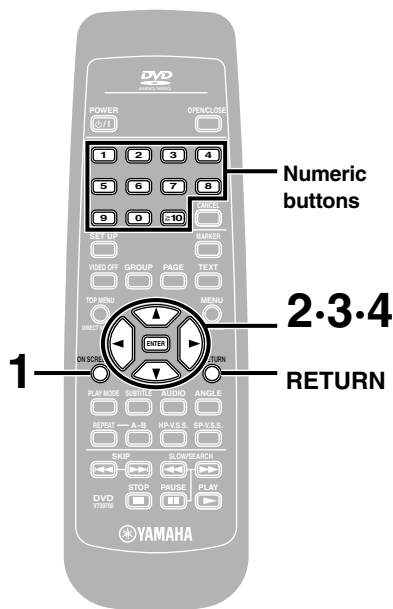

Using On-Screen Menu Icons

RAM DVD-A DVD-V VCD CD

Remote control only

On-Screen Menu Icons are menus that contain information about the disc or unit. These menus allow you to perform operations by changing this information.

Common procedures

1 Press [ON SCREEN].

Each time you press the button:

- Icons for disc information (a)
- ↓
- Icons for unit information (b)
- ↓
- Shuttle screen (c)
- ↓
- Original display (d)

•The screens depend on the disc contents.

2 Icons for unit information only

While the leftmost icon is highlighted

Press the cursor buttons [▲, ▼] to select the menu.

Each time you press the button:

- Play menu (e)
- ↓ ↑
- Display menu (f)
- ↓ ↑
- Audio menu (g)
- ↓ ↑
- Video menu (h)

3 Press the cursor buttons [◀, ▶] to select the item.

4 Press the cursor buttons [▲, ▼] to select the setting.

- Items with “▲” or “▼” above and below can be changed by [▲, ▼].
- Press [ENTER] if the setting does not change after pressing the cursor button [▲, ▼].
- Some items require different operations. Read the explanations on the following pages.

For your reference

- Depending on the condition of the unit (playing, stopped, etc.) and the type of disc you are playing, there are some items that you cannot select or change.
- When numbers are displayed (e.g. title No.), the numeric buttons are also effective for setting. When numbers are entered with the numeric buttons, press [ENTER] to register the setting.

To clear the icons

Press [RETURN] until the menu disappears.

To change the position of the icons

You can lower the position of the icons on the screen if they are cut off for some reason. There are 5 positions to choose from.

1. Press the cursor buttons [◀, ▶] to select the rightmost icon.
2. Press the cursor buttons [▲, ▼] to move the icons.



1 ON SCREEN



Example: DVD-Video

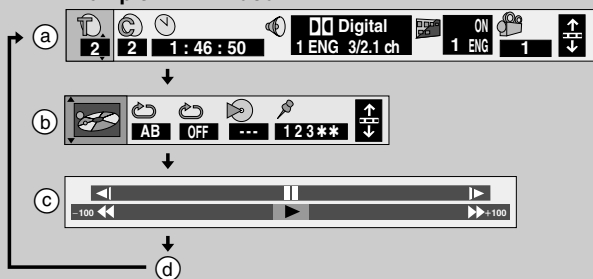

2

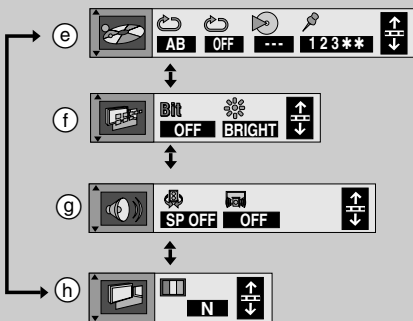
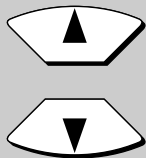

3

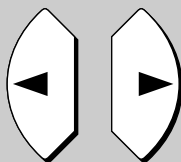

4

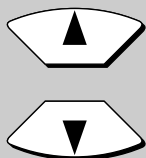

Icons for disc information

e.g. DVD-Video



Icon	Content
	RAM Program number
	RAM Play list number
	DVD-A Group number
	DVD-V Title number DVD-A VCD CD Track number
	DVD-V Chapter number
	DVD-A DVD-V Time RAM Elapsed play time of the program Select a position to start play by specifying a time with the numeric buttons. DVD-A VCD CD Changing the time display → Track elapsed time ↑ ↓ Track remaining time ↑ ↓ → Disc remaining time
	RAM VCD Audio mode LR ↔ L ↔ R
	DVD-A DVD-V Soundtrack language (See A at right for language abbreviations.)
	RAM DVD-A DVD-V Audio signal type (See B at right for details.)

Icon	Content
	DVD-A DVD-V Karaoke vocal on/off (Karaoke DVD only) Solo: OFF or ON Duet: OFF, V1+V2, V1 or V2
	DVD-A DVD-V Subtitle language (See A below for language abbreviations.)
	RAM DVD-A DVD-V Subtitles on/off ON ↔ OFF
	DVD-A DVD-V Angle number
	VCD (with playback control only) Menu play Indicates whether menu play (playback control) is on or off.
	DVD-A Still picture number Selected picture is shown during play

A Audio/Subtitle language

ENG: English	SVE: Swedish	CHI: Chinese
FRA: French	NOR: Norwegian	KOR: Korean
DEU: German	DAN: Danish	MAL: Malay
ITA: Italian	POR: Portuguese	VIE: Vietnamese
ESP: Spanish	RUS: Russian	THA: Thai
NLD: Dutch	JPN: Japanese	*: Others

B Signal type/data

LPCM/PPCM/Digital/DTS/MPEG: Signal type

k (kHz): Sampling frequency

b (bit): Number of bits

ch (channel): Number of channels

Example:

3/2 .1ch

.1: Subwoofer signal
(not displayed if there is no subwoofer signal)

0: No rear

1: Mono rear

2: Stereo rear (left/right)

1: Center

2: Main left+Main right

3: Main left+Main right+Center

Shuttle screen

Slow-motion play

◀: Backward **RAM** **DVD-A** **DVD-V**

Pause

Slow-motion play

▶: Forward **RAM** **DVD-A** **DVD-V** **VCD**

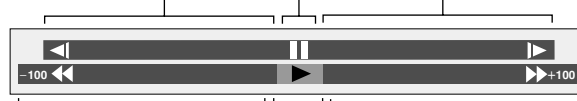

Search

◀◀: Backward

Play

Search

▶▶: Forward

Note

- There are five speeds for both backward and forward slow-motion and search.
- The numbers on either side of the shuttle screen indicate the maximum speeds of the search.
- Slow-motion only works on the moving picture parts of DVD-Audio.

Icons for unit information

Play menu

e.g. DVD-Video

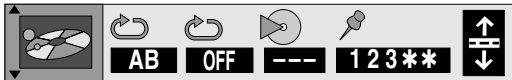

Icon	Content
	A-B repeat (⇒ page 21) [ENTER] (start point) ⇒ [ENTER] (finish point) To cancel [ENTER]
	Repeat play (⇒ page 21) RAM PG (Program) ↔ A (All) ↔ OFF ↑ ↓ During play list play S (Scene) ↔ PL (Play list) ↔ OFF ↑ ↓ DVD-V C (Chapter) ↔ T (Title) ↔ OFF ↑ ↓ DVD-A VCD CD T (Track) ↔ A (All)/G (Group) ↔ OFF ↑ ↓
	DVD-A VCD CD Play mode display ---: Normal play PGM: Program play RND: Random play ALL: All group play (DVD-A)
	Marker (⇒ page 16) DVD-A DVD-V VCD CD You can mark up to 5 positions to play again.
	RAM You can mark up to 999 positions to play again. [ENTER] (The unit is now ready to accept markers.)
	To mark a position [ENTER] (at the desired point)
	To mark multiple positions [▶] ⇒ [ENTER] (RAM ⇒ page 16)
	To recall a marker [◀, ▶] ⇒ [ENTER]
	To erase a marker [◀, ▶] ⇒ [CANCEL]

Note

- The marker function does not work during play list play.
- “PL” is not displayed while playing a specific play list scene.

Audio menu

e.g. DVD-Video



Icon	Content
	RAM DVD-V VCD VIRTUAL SURROUND (V.S.S.) mode (⇒ page 22) • SP-V.S.S. (Dolby Digital, DTS, MPEG, LPCM, 2-channel or over only) • HP-V.S.S. (Dolby Digital, MPEG, LPCM, 2-channel or over only)
	V.S.S. level (⇒ page 22) SP 1/HP 1 ↔ SP 2/HP 2 ↔ SP OFF/HP OFF ↑ ↓
	DVD-V (Dolby Digital/DTS, 3-channel or over only) Dialogue Enhancer ON ↔ OFF The volume of the dialogue from the center channel is raised when you select “ON”.

Display menu

e.g. DVD-Video



Icon	Content
	RAM DVD-V VCD Bit-rate display ON ↔ OFF Displays the bit rate and type of picture (approximate values) During play: Shows the average bit rate of the video being played While paused: Shows the data volume of the frame
	Display dimmer Changes the brightness of the unit's display. BRIGHT ↔ DIM ↔ AUTO* ↑ ↓

*The display dims and any indicators that were on turn off during play. The display brightens and the indicators light temporarily when you perform an operation.

Icons for unit information

Video menu

e.g. U1

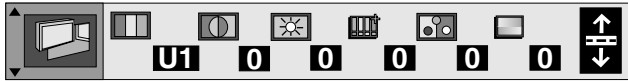

Icon	Content
	<p>RAM DVD-A DVD-V VCD</p> <p>Digital picture mode To select the picture mode: [▲, ▼] N: Normal mode S: Soft mode (Soft picture with fewer video artifacts) F: Fine mode (Details are sharper) C: Cinema mode (Picture for viewing movies) U1/U2/U3*/U4*: User mode *These settings are only possible when the PROGRESSIVE ON indicator is on (→ page 15). ●U4 settings are shown along with the N, S, F, and C modes when the progressive output indicator is on.</p> <p>To change the user mode</p> <ol style="list-style-type: none"> 1. Select User mode and press the cursor button [▶]. 2. Press the cursor buttons [▲, ▼] to select U1, U2, U3, or U4. 3. Press the cursor buttons [◀, ▶] to select the item you want to change. 4. Press the cursor buttons [▲, ▼] to change the setting.
	<p>U1 Contrast (–7 to +7) Increases the contrast between light and dark parts of the picture.</p>
	<p>Brightness (0 to +15) Brightens the picture.</p>
	<p>Sharpness (–6 to +6) Adjust the horizontal resolution of the picture.</p>
	<p>Color (–7 to +7) Adjust the shade of the picture's color.</p>
	<p>Gamma (0 to +5) Increases the brightness of the center ranges to improve detail and contrast in dark scenes.</p>
	<p>U2 3D-NR (0 to +4) Reduces overall noise.</p>
	<p>Block NR (0 to +3) Smooths block noise.</p>
	<p>Mosquito NR (0 to +3) Reduces the smudging that appears around contrasting sections of the picture.</p>

Icon	Content
	<p>U3* High sharpness (–6 to +6) Finely adjusts the sharpness of the picture horizontally.</p>
	<p>V sharpness (–1 to +2) Increases the sharpness of the picture vertically.</p>
	<p>Edge (–3 to 0) Improves edges in the background to reduce fuzziness and improve the sense of depth.</p>
	<p>TINT (–15 to +15) Change the overall tint of the picture.</p>
	<p>U4* Transfer MODE Select the method of conversion for progressive output to suit the type of material being played (→ page 34, "Film and video"). Auto 1 (normal): for viewing film material Auto 2: for viewing film material (the same as Auto 1, but able to convert 30-frame per second progressive video) Auto 3: for animated material (also able to convert 30-frame per second progressive video) Video: for video material</p>
	<p>4:3 ASPECT Select how to show video on a widescreen (16:9) television that is compatible with progressive output. Nor. (normal): The picture fills the whole screen. Auto: Letterbox format 4:3 aspect video expands to fill the screen or is shown in the center of the screen with black bands either side. Shr. (shrink): The picture is shown in the 4:3 aspect in the center of the television. Zoom: Select if video with an aspect of 4:3 recorded in the letterbox format is not expanded when "Nor." or "Auto" is selected.</p>
	<p>Shift Position (0 to +15) Shift the picture to show subtitles. (Works when the picture fills the screen when 4:3 ASPECT is set to "Auto" or "Zoom".)</p>
	<p>Output Change the tone of the picture. Nor. (normal): normal output Sepia: sepia toning Mono (monochrome): black and white Nega: brightness and tone are reversed</p>

Note

The unit saves the settings you make with the user mode for each disc so when you play a disc again and select a user mode, the same settings are selected. Discs you play for the first time use the previous settings. The unit can save settings for up to 200 discs. The settings for a disc are not saved if you switch to normal, soft, fine, or cinema mode before opening the disc tray or switching the unit to standby.

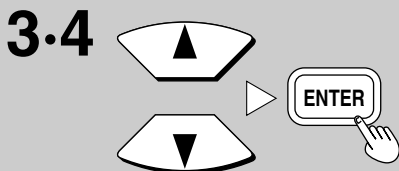
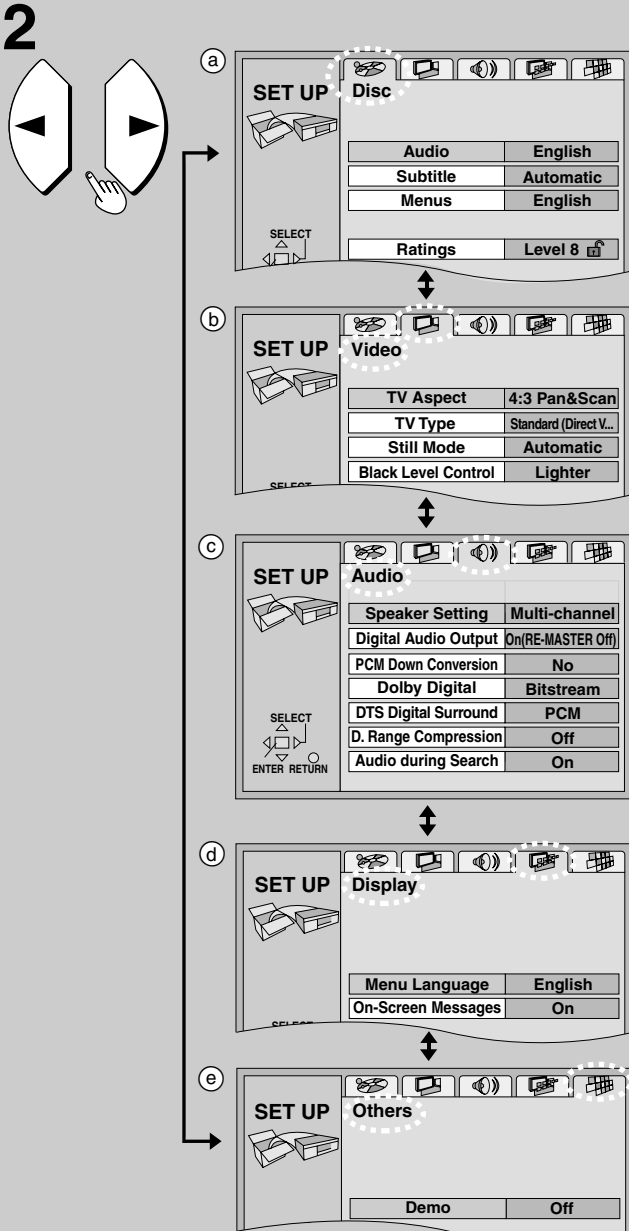
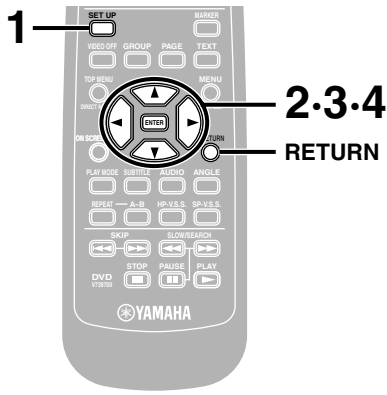

Changing settings

Remote control only

Change the settings to suit your preferences and to suit the unit to the environment in which it is being used. These settings are retained in memory until they are changed, even if the unit is turned off.

Common procedures

See page 29 for menu and option details.

- 1** Press [SET UP] to show the menus.
The screen shows the disc settings menu (a) first.
- 2** Press the cursor buttons [◀, ▶] to select the menu's tab.
The screen changes to display the menu.
 - Disc menu (a)
 - ↕
 - Video menu (b)
 - ↕
 - Audio menu (c)
 - ↕
 - Display menu (d)
 - ↕
 - Others menu (e)
- 3** Press the cursor buttons [▲, ▼] to select the item you want to change and press [ENTER].
- 4** Press the cursor buttons [▲, ▼] to select the option and press [ENTER].
The screen now shows the menu again.

To return to the previous screen
Press [RETURN].

When you are finished
Press [SET UP].

Summary of settings

This chart shows the settings for this unit. See page 28 for details on menu operation.

• Underlined items are the factory preset.

• The menu and on-screen message language has been factory preset to English. You can change the language by going to “Menu Language” in the Display menu.

Menus	Items	Options
Disc (⇒ Remarks page 30)	Audio <u>DVD-A</u> <u>DVD-V</u> Choose the preferred audio language.	<u>English</u> French Spanish Original Other ****
	Subtitle <u>DVD-A</u> <u>DVD-V</u> Choose the preferred subtitle language.	<u>Automatic</u> English French Spanish Other ****
	Menus <u>DVD-A</u> <u>DVD-V</u> Choose the preferred language for disc menus.	<u>English</u> French Spanish Other ****
	Ratings <u>DVD-V</u> Set a ratings level to limit DVD-Video play. • The password screen is shown if you choose levels 0 to 7 or if you choose “Ratings” when levels 0 to 7 have been selected (⇒ page 30). • Select “Level 0” to prevent play of discs that do not have ratings levels recorded on them.	Setting ratings (When level 8 is selected) 8 No Limit: All DVD-Video can be played. 1 to 7: Prohibits play of DVD-Video with corresponding ratings recorded on them. 0 Lock All: Prohibits play of all DVD-Video. <hr/> Changing ratings (When level 0–7 is selected) Unlock Player Change Level Change Password Temporary Unlock
Video	TV Aspect Choose the setting to suit your television and preference (⇒ page 31).	<u>4:3 Pan&Scan</u> 4:3 Letterbox 16:9
	TV Type Change the setting to suit your television (⇒ page 31).	<u>Standard (Direct View TV)</u> CRT Projector LCD Projector ProjectionTV
	Still Mode (⇒ Remarks page 30) Specify the type of picture shown when paused.	<u>Automatic</u> Field Frame
	Black Level Control Change the black level of the picture if you connected a television through the COMPONENT VIDEO OUT terminals.	<u>Lighter:</u> when connected to a TV through the VIDEO OUT or S VIDEO OUT terminal. <u>Darker:</u> when connected to a TV through the COMPONENT VIDEO OUT (Y/P _B /P _R) terminals.
Audio	Speaker Setting <u>DVD-A</u> <u>DVD-V</u> Choose the settings to suit your audio system and the listening environment (⇒ page 32).	<u>Multi-channel:</u> when 3 or more speakers are connected. • Speaker presence and size • Delay time • Channel balance <hr/> <u>2-channel:</u> when 2 speakers or an amplifier with a Dolby Pro Logic decoder is connected.
	Digital Audio Output Select whether to output digital signals or not.	<u>On:</u> Digital signals are output. <u>Off:</u> Digital signals are not output (improves sound quality when using analog connection)
	PCM Down Conversion <u>DVD-A</u> <u>DVD-V</u> Select how to output the audio signals on discs that do not have copyright protection (⇒ page 33).	<u>No</u> Yes
	Dolby Digital <u>DVD-A</u> <u>DVD-V</u> Digital output of Dolby Digital signals (⇒ page 33).	<u>Bitstream</u> PCM
	DTS Digital Surround <u>DVD-A</u> <u>DVD-V</u> Digital output of DTS Digital Surround signals (⇒ page 33).	<u>PCM</u> Bitstream
	D. Range Compression <u>RAM</u> <u>DVD-A</u> <u>DVD-V</u> (Dolby Digital only) Change the dynamic range for late night viewing.	<u>Off</u> On
	Audio during Search <u>RAM</u> <u>DVD-A</u> <u>DVD-V</u> <u>VCD</u> (⇒ Remarks page 30) Choose whether to have sound during search.	<u>On</u> Off
Display	Menu Language Choose the preferred language for these menus and the on-screen messages.	<u>English</u> Français Español
	On-Screen Messages Choose whether to show on-screen messages or not.	<u>On</u> Off
Others	Demo A demonstration of the unit's on-screen displays starts when you select “On”. The demonstration stops when you press a button and the setting reverts to “Off”.	<u>Off</u> On

Summary of settings

Remarks

■ Disc—Audio, Subtitle and Menus

Original: The original language of each disc will be selected.

Other **:** Input a code number with the numeric buttons (⇒ see below).

Automatic: If the language selected for “Audio” is not available, subtitles of that language will automatically appear if available on that disc.

● Some discs are designed to start in a certain language despite any changes you make here.

■ Video—Still Mode

Automatic: The unit automatically selects field still or frame still.

Field: Less blurred field stills are shown. Select if jittering occurs when “Automatic” is selected.

Frame: Sharper frame stills are shown. Select if small text or fine patterns cannot be seen clearly when “Automatic” is selected.

■ Audio—Audio during Search

Select “Off” if sound is interrupted when playing Dolby Digital 5.1-channel and DTS bitstream signals.

Audio will be heard when playing some DVD-Audio despite the settings you make here.

Entering a password

DVD-V

Refer also to Common procedures (⇒ page 28) and the Disc section in Summary of settings (⇒ page 29).

When setting ratings (When the level is 8)

The password screen is shown when you select levels 0 to 7.

1. Input a 4-digit password with the numeric buttons and press [ENTER].

● If you enter a wrong number, press [CANCEL] to erase it before you press [ENTER].

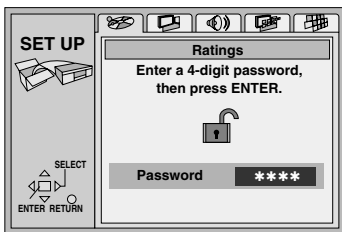

The lock symbol appears closed to show the rating is locked.

Do not forget your password.

2. Press [ENTER] to confirm the 4 digits.

Now, when you insert a DVD-Video that exceeds the ratings limit you set, a message appears on the television. Follow the on-screen instructions.

When changing ratings (When the level is 0 to 7)

The password screen is shown when you select “Ratings”.

1. Input your 4-digit password with the numeric buttons and press [ENTER].

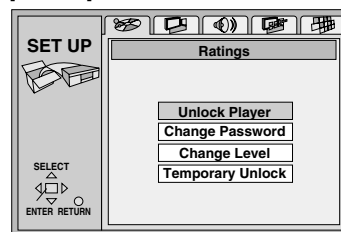

2. Select the item with the cursor buttons [▲, ▼] and press [ENTER], and follow the on-screen instructions.

Language code list

Abkhazian: 6566	Chinese: 9072	Hausa: 7265	Lithuanian: 7684	Romanian: 8279	Telugu: 8469
Afar: 6565	Corsican: 6779	Hebrew: 7387	Macedonian: 7775	Russian: 8285	Thai: 8472
Afrikaans: 6570	Croatian: 7282	Hindi: 7273	Malagasy: 7771	Samoan: 8377	Tibetan: 6679
Albanian: 8381	Czech: 6783	Hungarian: 7285	Malay: 7783	Sanskrit: 8365	Tigrinya: 8473
Ameharic: 6577	Danish: 6865	Icelandic: 7383	Malayalam: 7776	Scots Gaelic: 7168	Tonga: 8479
Arabic: 6582	Dutch: 7876	Indonesian: 7378	Maltese: 7784	Serbian: 8382	Turkish: 8482
Armenian: 7289	English: 6978	Interlingua: 7365	Maori: 7773	Serbo-Croatian: 8372	Turkmen: 8475
Assamese: 6583	Esperanto: 6979	Irish: 7165	Marathi: 7782	Shona: 8378	Twi: 8487
Aymara: 6588	Estonian: 6984	Italian: 7384	Moldavian: 7779	Sindhi: 8368	Ukrainian: 8575
Azerbaijani: 6590	Faroese: 7079	Japanese: 7465	Mongolian: 7778	Singhalese: 8373	Urdu: 8582
Bashkir: 6665	Fiji: 7074	Javanese: 7487	Nauru: 7865	Slovak: 8375	Uzbek: 8590
Basque: 6985	Finnish: 7073	Kannada: 7578	Nepali: 7869	Slovenian: 8376	Vietnamese: 8673
Bengali, Bangla: 6678	French: 7082	Kashmiri: 7583	Norwegian: 7879	Somali: 8379	Volapük: 8679
Bhutan: 6890	Frisian: 7089	Kazakh: 7575	Oriya: 7982	Spanish: 6983	Welsh: 6789
Bihari: 6672	Galician: 7176	Kirghiz: 7589	Pashto, Pushto: 8083	Sundanese: 8385	Wolof: 8779
Breton: 6682	Georgian: 7565	Korean: 7579	Persian: 7065	Swahili: 8387	Xhosa: 8872
Bulgarian: 6671	German: 6869	Kurdish: 7585	Polish: 8076	Swedish: 8386	Yiddish: 7473
Burmese: 7789	Greek: 6976	Laotian: 7679	Portuguese: 8084	Tagalog: 8476	Yoruba: 8979
Byelorussian: 6669	Greenlandic: 7576	Latin: 7665	Punjabi: 8065	Tajik: 8471	Zulu: 9085
Cambodian: 7577	Guarani: 7178	Latvian, Lettish: 7686	Quechua: 8185	Tamil: 8465	
Catalan: 6765	Gujarati: 7185	Lingala: 7678	Rhaeto-Romance: 8277	Tatar: 8484	

Television settings

Change the settings to suit your television and your preference. Refer also to Common Procedures (➔ page 28) and the Video section in Summary of settings (➔ page 29).

TV Aspect

4:3 Pan&Scan (Factory preset)

Select if you have a regular television and to view 16:9 software in the pan and scan style.



16:9 software prohibited from being shown in the pan and scan style will appear in the letterbox style despite the setting here.

4:3 Letterbox

Select if you have a regular television and to view 16:9 software in the letterbox style.



16:9

Select if you have a widescreen television.

For your reference

DVDs are recorded in a variety of aspect ratios and how these appear depend on these settings, the on-screen menu settings, and the television's screen modes.

- When connected to a regular 4:3 aspect television, use these settings.
- When connected to a widescreen 16:9 aspect television using progressive output, use the on-screen menu icons (➔ page 27 "4:3 ASPECT").
- When connected to a widescreen 16:9 aspect television using interlace output, use the television's screen modes.

TV Type

Standard (Direct View TV) (Factory preset)

Select if you have a standard television, widescreen television, wide-screen plasma television, etc.

CRT Projector

Select if you have a DLP Projector or a CRT Projector.

LCD Projector

Select if you have an LCD Projector.

Projection TV

Select if you have a Projection TV.

The optimum settings for your television may differ.

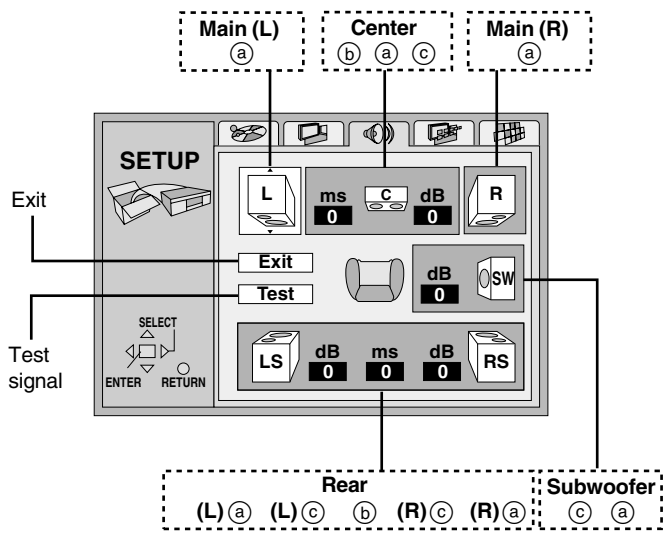
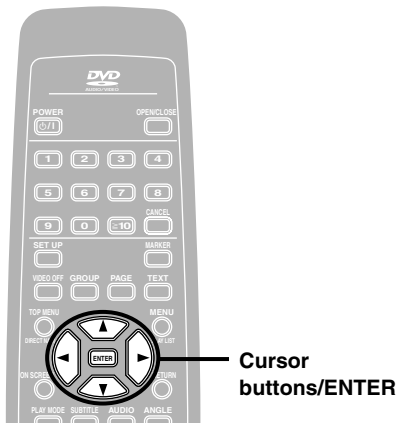

A

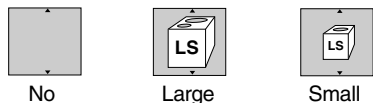

B

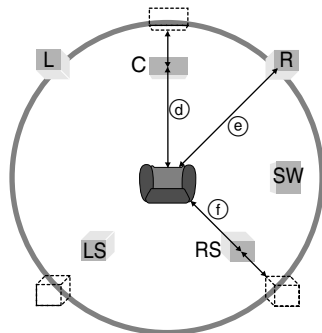

●Center speaker

Difference	Setting
Approx. 50 cm (1½ feet)	1.3 ms
Approx. 100 cm (3 feet)	2.6 ms
Approx. 150 cm (5 feet)	3.9 ms
Approx. 200 cm (6 feet)	5.3 ms

●Rear speakers

Difference	Setting
Approx. 200 cm (6 feet)	5.3 ms
Approx. 400 cm (12 feet)	10.6 ms
Approx. 600 cm (18 feet)	15.9 ms

Changing settings

Speaker setting

DVD-A DVD-V

Change speaker size and presence (a), delay time (b), and channel balance (c) to suit the speakers you have connected. These settings are not necessary when you select “2-channel” (only two speakers are connected).

Speaker presence and size (a)

1. Press the cursor buttons [▲, ▼, ◀, ▶] to select the item and press [ENTER].
2. Press the cursor buttons [▲, ▼] to select the setting and press [ENTER].

Icon examples: Rear speaker (L) **A**

Large: When the speaker supports low-frequency (under 100 Hz) reproduction.
Small: Select when the speaker does not support low-frequency reproduction.

The size setting for the main speakers is automatically determined by the setting for the subwoofer.

B Delay time (b)

DVD-V (Dolby Digital, center and rear speakers only)

For optimum listening with 5.1-channel sound, all the speakers, except for the subwoofer, should be the same distance from the seating position. If you have to place the center or rear speakers closer to the seating position, adjust the delay time to make up for the difference. If distance (d) (from the center speaker) and (f) (from the rear speakers) are the same as or greater than (e) (from the main speakers), leave the delay time as “0”, the factory preset. If either distance (d) or (f) is less than (e), find the difference in the relevant table and change to the recommended setting.

Changing the delay time

1. Press the cursor buttons [▲, ▼, ◀, ▶] to select the delay time box and press [ENTER].
2. Press the cursor buttons [▲, ▼] to adjust the delay time and press [ENTER].

Speaker balance (c)

1. Press the cursor buttons [▲, ▼, ◀, ▶] to select “Test” and press [ENTER].

A test signal is output from one speaker at a time, starting with the main left speaker and proceeding clockwise.

MAIN (L) → CENTER → MAIN (R)

REAR (L) ← REAR (R)

2. While listening to the test signal, press the cursor buttons [▲, ▼] to adjust the volume of the center and rear speakers so they are the same apparent volume as the main speakers. (The main speakers cannot be adjusted here.)

3. Press [ENTER].

The test signal stops.

Note

No signal is output for the subwoofer. To adjust its volume, play something, then return to this screen to adjust to suit your taste.

When you are finished

Press the cursor buttons [▲, ▼, ◀, ▶] to select “Exit” and press [ENTER].

Note

The unit may be unable to output as set here due to limitations imposed by the unit itself or the disc being played. (The FL display’s “P.PCM” indicator lights or “D.MIX” indicator goes out in these cases.)

DVD-A DVD-V

Digital output

Change these settings when you have connected equipment through this unit's DIGITAL AUDIO OUT terminals (OPTICAL or COAXIAL). Refer also to Common procedures (➔ page 28) and the Audio section in Summary of settings (➔ page 29).

PCM Down Conversion

Select how to output the high-quality audio signals (sampling frequencies of 96 kHz and 88.2 kHz) on discs that do not have copyright protection. Choose the settings to suit the equipment you have connected.

Setting	Equipment (Able to handle 88.2 kHz or more)	Audio output
No ^{*1}	Yes	Output as is
Yes	No	Down-sampled to 48 kHz or 44.1 kHz

*1 The equipment cannot output signals of 88.2 kHz or more if the setting is "No" and the equipment is unable to handle these signals.

Note

Signals are down-sampled to either 48 kHz or 44.1 kHz despite the above settings if they have a sampling frequency of 176.4 kHz or more or are copyright protected.

Dolby Digital

Bitstream (Factory preset):

When you have connected a unit with a built-in Dolby Digital decoder.

PCM:

When you have connected a unit that doesn't have a built-in Dolby Digital decoder.*

DTS Digital Surround

PCM (Factory preset):

When you have connected a unit that doesn't have a built-in DTS decoder.*

Bitstream:

When you have connected a unit with a built-in DTS decoder.

*These changes to digital audio output must be made, otherwise bitstream signals the decoder cannot handle will be output. If these signals are output, "noise" will be output which can cause harm to your ears and speakers.

Bitstream

This is the digital form of multiple channel audio data (e.g., 5.1 channel) before it is decoded into its various channels.

Decoder

A decoder restores the coded signals on DVDs to normal. This is called decoding.

Dolby Digital

This is a method of coding digital signals developed by Dolby Laboratories. Apart from stereo (2-channel) audio, these signals can also be 5.1-channel audio. A large amount of audio information can be recorded on one disc using this method.

Dolby Pro Logic

A surround system where a 4-channel audio track is recorded as 2 channels and then is restored to 4 channels for play. The surround channel is monaural and can reproduce up to 7 kHz.

DTS (Digital Theater Systems)

This surround system is used in many movie theaters around the world. There is good separation between the channels, so realistic sound effects are possible.

Dynamic range

Dynamic range is the difference between the lowest level of sound that can be heard above the noise of the equipment and the highest level of sound before distortion occurs.

Film and video

DVDs are recorded using either film or video. Film is recorded at 24 frames per second, the rate movies are filmed at, although some recent progressive material is recorded at 30 frames per second. Video is recorded at 30 frames per second.

Frame still and field still

A still is shown when you pause a moving picture. A frame still is made up of two alternating fields, so the picture may appear blurred, but overall quality is high.

A field still is not blurred, but it has only half the information of a frame still so picture quality is lower.

Frames are the still pictures that go together to make a moving picture. There are about 30 frames shown each second.

One frame is made up of two fields. A regular television shows these fields one after the other to create frames.

Interlace and progressive output

NTSC, the video signal standard, has 480 interlaced (i) scan lines, whereas progressive scanning uses twice the number of scan lines. This is called 480p. The 480i video signals output from this unit's COMPONENT VIDEO OUT terminals (Y, P_B/C_B, P_R/C_R) allow you to enjoy higher quality pictures than if the signals were output from the video output terminal or S VIDEO OUT terminal. The COMPONENT VIDEO OUT terminals are also able to handle 480p (progressive) video signals which are of even greater resolution.

I/P/B

MPEG, the video compression standard adopted for use with DVD-Video, codes frames using these 3 picture types.

I: Intra coded picture (I-picture)

This is the standard picture and is a complete picture in itself.

This means it has the best picture quality and is the best to use when adjusting the picture.

P: Predictive coded picture (P-picture)

This picture is calculated based on past I or P-pictures.

B: Bidirectionally-predictive coded picture (B-picture)

This picture is calculated by comparing past and future I and P-pictures so it has the lowest volume of information.

Linear PCM (pulse code modulation)

PCM is the usual digital method used for music CDs. DVDs have a greater volume so they use linear PCM, which has a higher sampling rate. Compressed PCM signals are called packed PCM (PPCM).

Optical digital audio cable

This cable carries optical digital signals to the amplifier to reduce noise caused by electronic interference.

Pan&Scan/Letterbox

In general, DVD-Video are produced with the intention that they be viewed on a widescreen television with an aspect ratio of 16:9. This means you can view most material with the intended aspect ratio on a widescreen television.

Material with this ratio will not fit onto a standard television with an aspect ratio of 4:3. Two styles of picture, "Pan&Scan" and "Letterbox", deal with this problem.

Pan&Scan: The sides are cut off so the picture fills the screen.

Letterbox: Black bands appear at the top and bottom of the picture so the picture itself appears in an aspect ratio of 16:9.

Playback control (PBC)

If a Video CD has "playback control" written on it or its jacket, it means that particular scenes or information can be selected for viewing interactively with the television using the menu screen. This unit can play Video CDs with playback control.

Using menus to control play of a Video CD is called "menu play" in these operating instructions.

Play list

This is a collection of scenes. It enables you to play these scenes in succession or to select specific ones to play.

Program

This is a division on DVD-RAM.

Direct navigator

This is a list of programs you have recorded. You can select programs from the list to view. The list also shows the date and time of recording, the channel, and the titles of titled programs. The selected program is played in the background, making selection even simpler.

Sampling rate

This is the number of samples of sound taken per second during conversion to a digital signal. Sampling frequency is expressed in kilohertz (kHz). A high sampling frequency results in a sound close to the original when played back.

Title/Chapter

DVD-Video are divided up into large sections, titles, and smaller sections, chapters. The numbers allocated to these sections are called title numbers and chapter numbers.

Track

This is the smallest division on DVD-Audio, CD, and Video CD, and usually equates to a single song.

Troubleshooting guide

Before requesting service for this player, check the chart below for a possible cause of the problem you are experiencing. Some simple checks or a minor adjustment on your part may eliminate the problem and restore proper operation.

If you are in doubt about some of the check points, or if the remedies indicated in the chart do not solve the problem, contact your authorized YAMAHA dealer or service center for instructions.

Reference pages are shown as black circled numbers ⑨.

Power

No power.	<ul style="list-style-type: none"> ● Insert the AC power supply cord securely into the household AC outlet. ⑨
The unit is automatically switched to the standby mode.	<ul style="list-style-type: none"> ● To conserve power, the unit automatically switches to standby after approximately 30 minutes in the stop mode. Turn the power back to ON.

Operation

No response when buttons pressed.	<ul style="list-style-type: none"> ● Some operations may be prohibited by the disc. ● The unit may not be operating properly due to lightning, static electricity or some other external factor. <p>Reset procedure: Press [STANDBY/ON] to switch the unit to the standby mode and then back to ON. Alternatively, press [STANDBY/ON] to switch the unit to the standby mode, disconnect the AC power supply cord, and then reconnect it.</p>
No operations can be performed with the remote control.	<ul style="list-style-type: none"> ● Check the batteries are installed correctly. ③ ● The batteries are depleted: Replace them with new ones. ③ ● Point the remote control at the remote control sensor and operate. ③
Play fails to start even when [▶] (PLAY) is pressed. Play starts but then stops immediately.	<ul style="list-style-type: none"> ● Condensation has formed: Wait 1 to 2 hours for it to evaporate. ● This unit cannot play discs other than DVD-RAM, DVD-Audio, DVD-Video, Video CD and CD. ⑤ ● This unit cannot play DVD-Video with a region number other than "1", "ALL" or multiple region numbers including "1". ⑤ ● The disc may be dirty and may require cleaning. ⑥ ● Ensure that the disc is installed with the label of the side to be played facing upwards. ⑫ ● Check that the DVD-RAM has something recorded on it.
Alternative languages fail to be selected.	<ul style="list-style-type: none"> ● An alternative language is not selected with discs which do not contain more than one language. ● In the case of some discs, the alternative language cannot be selected with [AUDIO] or [SUBTITLE]. Try selecting it from the disc's menu if one is available. ⑩
No subtitles.	<ul style="list-style-type: none"> ● Subtitles appear only with discs that contain them. ● Subtitles are cleared from the television. Display the subtitles. ⑳ ● Some subtitles recorded around point A or B may fail to appear. ㉑
Soundtrack and/or subtitle language is not the one selected with the SET UP menus.	<ul style="list-style-type: none"> ● The language is not recorded on the disc.
Angle cannot be changed.	<ul style="list-style-type: none"> ● This function is dependent on software availability. Even if a disc has a number of angles recorded, these angles may be recorded for specific scenes only. ㉓
You have forgotten your ratings password. Reset all the settings to Factory Preset.	<ul style="list-style-type: none"> ● While stopped, press and hold [⏮/◀] and [⏭] on the unit and then also press and hold [▲] on the unit until "Initialized" disappears from the television. Turn the unit off and on again. All settings will return to the default values.

Sound

No sound. Distorted sound.	<ul style="list-style-type: none"> ● Check the connections. ⑨ ⑩ ⑪ ● Check the volume on the equipment you have connected. ● Ensure that the input settings for the television and stereo system are correct. ● If you have connected this unit to an amplifier through the AUDIO OUT terminals, go to the Audio menu in the SET UP menus, and change "Speaker Setting" to suit your speakers. Select the large or small icon for all the speakers you have connected. ㉒ ● Turn Virtual Surround off if it causes distortion. ㉒ ● Output from this unit will be in stereo (two channels) when Virtual Surround is on. Turn Virtual Surround off if you are using three or more speakers. ㉒ ● Due to the specifications on some types of televisions, both video and audio may be cut off when you turn the VIDEO OFF feature on. ⑮ ● If the "D.MIX" indicator on the FL display goes out while playing a multi-channel DVD-Audio disc, sound will only be output from speakers specified by the disc. Read the disc's instructions for details.
Piercing noise comes from the speakers.	<ul style="list-style-type: none"> ● If you have connected this unit to other equipment through the DIGITAL AUDIO OUT terminal, ensure you have selected the correct settings for "Dolby Digital" and "DTS Digital Surround" in the SET UP menu's Audio menu. ㉔

Picture

Picture distorted.	<ul style="list-style-type: none"> Some distortion is normal during SEARCH. The screen may be disrupted briefly when you turn off the VIDEO OFF feature. 15
No picture.	<ul style="list-style-type: none"> Ensure that the equipment is connected properly. 9 11 Make sure the television is on. Ensure the television's video input setting (e.g., VIDEO 1) is correct. If "This disc is PAL system. The output is sound only." is on the television, then you have loaded a PAL system DVD-Audio and only the audio portion of the disc can be played.
The picture shown on the television is not normal. (The sides of the picture are cut off or black bands appear at the top and bottom of the screen.)	<ul style="list-style-type: none"> Go to the Video menu in the SET UP menus, and change "TV Aspect" to suit your television. You may also need to change the screen mode on the television itself. 31 If you are using progressive output, try changing 4:3 ASPECT and Shift Position with the on-screen menu icons. 27 Ensure that the unit is not connected through a video cassette recorder. 9 You cannot view progressive video if your television is not designed to receive progressive signals. Press [PROGRESSIVE ON] to turn PROGRESSIVE ON off. 15
There is ghosting when progressive output is on.	<ul style="list-style-type: none"> Turn PROGRESSIVE ON off. This problem is caused by the editing method or material used on the DVD, but should be corrected if you use interlace output. 15
Colors are strange.	<ul style="list-style-type: none"> Check the setting for output with the on-screen menu icons. 27
Picture quality is poor.	<ul style="list-style-type: none"> Check the settings in the on-screen menu's video menu. 27
There is a lot of ghosting.	<ul style="list-style-type: none"> Use the on-screen menu icons to adjust the picture quality. 27

Displays

"No Play" appears on the unit's display.	<ul style="list-style-type: none"> You inserted a disc the unit cannot play; insert one it can. 5 You inserted a blank DVD-RAM.
No on-screen display.	<ul style="list-style-type: none"> Go to Display in the SET UP menus, and select "On" for "On-Screen Messages". 25
On-Screen Menu Icons not displayed or only partially displayed on the television.	<ul style="list-style-type: none"> Press the cursor buttons [▲, ▼] while the rightmost icon is highlighted to move them down. 24
The disc's menu is displayed in a different language.	<ul style="list-style-type: none"> Go to Disc in the SET UP menus, and select the preferred language for "Menus". 25
No menu play.	<ul style="list-style-type: none"> Menus are only displayed if they are recorded on the disc.
"Check The Disc" appears on the unit's display.	<ul style="list-style-type: none"> Disc is dirty. Wipe the disc clean. 6
"Error" appears on the unit's display.	<ul style="list-style-type: none"> The track playing has been recorded with a nonstandard system.
"H□□" appears on the unit's display. □□ stands for a number.	<ul style="list-style-type: none"> Trouble is likely to have occurred. The number following "H" depends on the status of the unit. Reset procedure: Press [STANDBY/ON] to switch the unit to the standby mode and then back to ON. Alternatively, press [STANDBY/ON] to switch the unit to the standby mode, disconnect the AC power supply cord, and then reconnect it. If the service numbers fail to clear, note the service number and contact a qualified service person.
"No Disc" appears on the unit's display.	<ul style="list-style-type: none"> You haven't inserted a disc; insert one. You haven't inserted the disc correctly; insert it correctly. 12

Maintenance

To clean this unit, wipe with a soft, dry cloth.

- Never use alcohol, paint thinner or benzine to clean this unit.
- Before using chemically treated cloth, read the instructions that came with the cloth carefully.

Specifications

Power supply:	AC 120 V, 60 Hz
Power consumption:	16 W
Power consumption in standby mode:	approx. 2 W
Dimensions:	449 (W)×281 (D)×99 (H) mm [17 ¹¹ / ₁₆ " (W)×11 ¹ / ₁₆ " (D)×3 ²⁹ / ₃₂ " (H)] (excluding protrusions)
Weight:	3.5 kg (7.72 lb.)
Signal system:	NTSC
Operating temperature range:	+5 to +35 °C (+41 to +90 °F)
Operating humidity range:	5–90 % RH (no condensation)
Discs played:	
(1) DVD-RAM (DVD-VR compatible)	
(2) DVD-Video	
(3) DVD-Audio	
(4) CD-Audio (CD-DA)	
(5) Video CD	
(6) CD-R/CD-RW (CD-DA, Video CD formatted discs)	
Video output:	
Output level:	1 Vp-p (75 Ω)
Output connector:	Pin jack
Number of connectors:	2 systems
S video output:	
Y output level:	1 Vp-p (75 Ω)
C output level:	0.286 Vp-p (75 Ω)
Output connector:	S terminal
Number of connectors:	1 system
Component video output (480P/480i):	
Y output level:	1 Vp-p (75 Ω)
P _B output level:	0.7 Vp-p (75 Ω)
P _R output level:	0.7 Vp-p (75 Ω)
Output connector:	Pin jack (Y: green, P _B : blue, P _R : red)
Number of connectors:	1 system

Audio output:	
Output level:	2 Vrms (1 kHz, 0 dB)
Output connector:	Pin jack
Number of connectors:	
2CH:	1 system
5ch discrete output (5.1 ch):	1 system

Audio signal output characteristics:

- Frequency response:
 - DVD (linear audio): 2 Hz–22 kHz (48 kHz sampling)
2 Hz–44 kHz (96 kHz sampling)
 - DVD-Audio: 2 Hz–88 kHz (192 kHz sampling)
 - CD audio: 2 Hz–20 kHz
- S/N ratio:
 - CD audio: 115 dB
- Dynamic range:
 - DVD (linear audio): 103 dB
 - CD audio: 99 dB
- Total harmonic distortion:
 - CD audio: 0.002 %

Digital audio output:

Optical digital output:	Optical terminal
Coaxial digital output:	Pin jack

Phones jack:

Pickup:	Wave length: 658 nm/790 nm
	Laser power: CLASS IIa/CLASS I

Note

Specifications are subject to change without notice.
Weight and dimensions are approximate.

Apparatus Claims of U.S. Patent Nos. 4,631,603, 4,577,216, and 4,819,098, licensed for limited viewing uses only.

This product incorporates copyright protection technology that is protected by method claims of certain U.S. patents and other intellectual property rights owned by Macrovision Corporation and other rights owners. Use of this copyright protection technology must be authorized by Macrovision Corporation, and is intended for home and other limited viewing uses only unless otherwise authorized by Macrovision Corporation. Reverse engineering or disassembly is prohibited.



YAMAHA ELECTRONICS CORPORATION, USA 6660 ORANGETHORPE AVE., BUENA PARK, CALIF. 90620, U.S.A.
YAMAHA CANADA MUSIC LTD. 135 MILNER AVE., SCARBOROUGH, ONTARIO M1S 3R1, CANADA
YAMAHA ELECTRONIK EUROPA G.m.b.H. SIEMENSSTR. 22-34, 25462 RELINGEN BEI HAMBURG, F.R. OF GERMANY
YAMAHA ELECTRONIQUE FRANCE S.A. PA PARIS-EST RUE AMBROISE CROIZAT CROISSY-BEAUBOURG BP70-77312 MARNE LAVALLEE, CEDEX 2 FRANCE
YAMAHA ELECTRONICS (UK) LTD. YAMAHA HOUSE, 200 RICKMANSWORTH ROAD WATFORD, HERTS WD1 7JS, ENGLAND
YAMAHA SCANDINAVIA A.B. J A WETTERGRENS GATA 1, BOX 30053, 400 43 VÄSTRA FRÖLUNDA, SWEDEN
YAMAHA MUSIC AUSTRALIA PTY, LTD. 17-33 MARKET ST., SOUTH MELBOURNE, 3205 VIC., AUSTRALIA

YAMAHA CORPORATION
© Printed in Japan